



APPLICATION MANUAL

2018/19

SWAROVSKI

CONTENTS

7 GENERAL INFORMATION

- 8 APPLICATION MANUAL
- 8 APPLICATION ONLINE
- 9 APPLICATION SERVICES
- 12 SWAROVSKI PRODUCTS AND SUITABLE APPLICATION TECHNIQUES
- 14 GENERAL PRODUCT INFORMATION

23 SOLDERING, STONE SETTING, AND PLATING

- 24 PRODUCT OVERVIEW
- 24 MACHINES AND TOOLS
- 26 SUPPLIERS
- 27 APPLICATION
- 38 USEFUL INFORMATION
- 40 QUICK ASSISTANCE

43 GLUING

- 44 PRODUCT OVERVIEW
- 44 MACHINES AND TOOLS
- 48 SUPPLIERS
- 50 APPLICATION
- 73 USEFUL INFORMATION
- 77 QUICK ASSISTANCE

81 CERALUN

- 82 PRODUCT OVERVIEW
- 83 MACHINES AND TOOLS
- 85 SUPPLIERS
- 86 APPLICATION
- 94 USEFUL INFORMATION
- 95 QUICK ASSISTANCE

97 SELF-ADHESIVE ELEMENTS

- 98 PRODUCT OVERVIEW
- 100 MACHINES AND TOOLS
- 101 SUPPLIERS
- 102 APPLICATION
- 115 QUICK ASSISTANCE

117 HOTFIX APPLICATION

- 118 PRODUCT OVERVIEW
- 118 MACHINES AND TOOLS
- 120 SUPPLIERS
- 121 APPLICATION
- 132 USEFUL INFORMATION
- 137 QUICK ASSISTANCE
- 138 SWAROVSKI HOTFIX SELECTOR

149 SEWING, EMBROIDERY, AND HAND APPLICATION

- 150 PRODUCT OVERVIEW
- 151 MACHINES AND TOOLS
- 154 SUPPLIERS
- 155 APPLICATION
- 163 USEFUL INFORMATION
- 165 QUICK ASSISTANCE

167 MECHANICAL APPLICATION

- 168 PRODUCT OVERVIEW
- 168 MACHINES AND TOOLS
- 175 SUPPLIERS
- 179 APPLICATION
- 192 USEFUL INFORMATION
- 193 QUICK ASSISTANCE

195 CARE INSTRUCTIONS

- 196 TEXTILE CARE INSTRUCTIONS
- 199 GENERAL CARE INSTRUCTIONS
- 200 LAWS, REGULATIONS, NORMS, AND STANDARDS
- 200 WARNING NOTICES



TO PREDICT THE FUTURE, WE INVENTED IT.

Stay ahead with our Advanced Crystal. It is lead-free* and helps you to reach full compliance with current laws and regulations.

*Crystal glass and all other materials containing 0.009% lead or less.

SWAROVSKI

WHY SWAROVSKI

EXCELLENCE, THROUGH INNOVATION AND ORIGIN

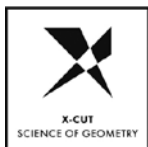

X-CUT

Advanced optical measurement and high-precision manufacturing deliver premium cuts characterized by unmatched brilliance.



PLATINUM* PRO

With its new advanced foiling technique, Swarovski has set a new standard in the lifespan of crystals.



HOTFIX GLUE

The variable temperatures at which Hotfix glue can be activated enable the application of crystals on a broad range of textiles.



CRYSTALS – MADE IN AUSTRIA

The combination of innovation with sustainability and respect for individual wellbeing means that quality is always assured.

PREMIUM, BY SERVICE AND DESIGN



DESIGN SERVICE

Throughout its global network of Design Centers, Swarovski offers exceptional service provided by the industry's best creative talent.



APPLICATION SERVICE

A comprehensive range of application services means customers benefit from the extensive experience of leading international experts, as well as internal specialists.



GLOBAL SERVICE

Swarovski's Global Service Network provides customers with dedicated personal assistance on a local level.



DESIGNER EDITIONS

Creative collaborations with top designers result in exclusive cuts and unique designs for Swarovski crystals.

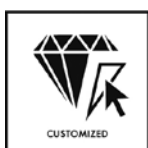

CUSTOMIZED SERVICE

Choose new variations by going beyond Swarovski's tremendous standard assortment of crystal components and forward integrated elements.

COMPLIANCE, WITH INTEGRITY

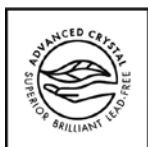

ADVANCED CRYSTAL

Swarovski's patented lead-free** formula has changed the DNA of crystal while still offering the same sparkle, dependability, and variety for which Swarovski is famous.



OEKO-TEX

Oeko-Tex® Standard 100 Class II (direct contact with skin) certification creates confidence in chemical safety of textile applications.



CLEAR

Regular legal monitoring of chemical requirements and reasonable testing provide customers with the comfort of trust in Swarovski's products.



COMPLIANCE SERVICE

Assessments regarding substance limitations as well as compliance information and advice to support customers in complying with relevant laws, regulations, and voluntary standards.

* Silver mirror coated with a platinum colored protective layer.

** Crystal glass and all other materials containing 0.009% lead or less.



1

GENERAL INFORMATION

Swarovski offers a comprehensive range of services, tailored to customers' requirements, for the application of Swarovski products.

- 8** Application Manual
- 8** Application Online
- 9** Application Services
- 12** Swarovski Products and Suitable Application Techniques
- 14** General Product Information

APPLICATION MANUAL

This Application Manual offers extensive information on the various Application Services provided by Swarovski. Thanks to their outstanding quality, and with the help of specially

developed application techniques, Swarovski products can be processed easily and quickly to produce a high-quality finished product. The processes involved are described

in this manual on a step-by-step basis, with photos and illustrations. Each application method contains detailed information on the following areas:

Product Overview	Swarovski products that are suitable for the application technique in question
Machines and Tools	List of machines and tools necessary for application
Suppliers	Selection of suppliers that sell these machines and tools
Application	Detailed description of the entire application process and the product-specific procedure. Furthermore, the Hotfix Selector outlines extensive application parameters for suitable product and carrier material combinations
Useful Information	Advice and tips on working with Swarovski products
Quick Assistance	A checklist of typical application problems, along with possible causes and recommendations on avoiding them

Extensive care instructions and further information on laws, regulations, norms, and standards are featured at the end of the manual.

APPLICATION ONLINE: SWAROVSKI-PROFESSIONAL.COM

All the information contained in this manual is regularly updated on the Swarovski business website SWAROVSKI-PROFESSIONAL.COM. In addition, application techniques are

demonstrated through animations and videos. The site is an excellent way to find out about Swarovski's application services and application techniques.

CRYSTAL APPLICATION TECHNIQUES - NEW INSTRUCTION MOVIES

For many crystal application techniques and their most important process steps, Swarovski provides informative demonstration movies, where detailed instructions lead customers to a high quality application result. This movies can be downloaded at SWAROVSKI-PROFESSIONAL.COM



APPLICATION SERVICES

Swarovski offers a comprehensive range of services, tailored to your requirements, for applying Swarovski products. In doing so, the company aims to meet the needs of each industry, and to jointly offer flexible and integrated solutions.

- Technical enquiry service
- Compliance service
- Technical customer support - field services
- Application Partner Network

TECHNICAL ENQUIRY SERVICE

Available worldwide, the technical enquiry service can help you in the following areas:

- Product information
- Technical drawing
- Care instructions
- Information on industry standards
- Individual application tests based on customer samples
- Information on machines and tools

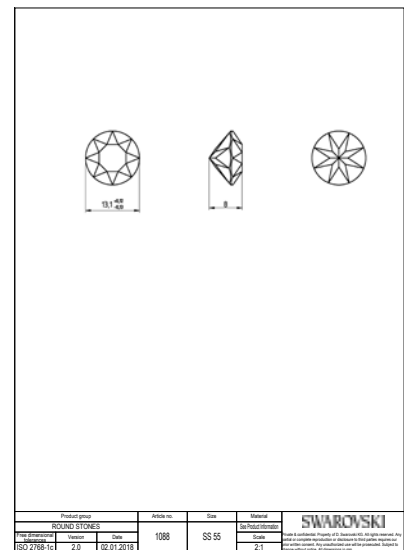

COMPLIANCE SERVICE

The worldwide available compliance service can support you in the following areas:

- Certificates
- Information on laws and regulations
- Compliance information of Swarovski crystals
- Compliance statement to customer-specific requirements



For further information, please contact your local Swarovski office.

TECHNICAL CUSTOMER SUPPORT – FIELD SERVICES

Swarovski imparts its crystal application expertise through customized

Crystal Application Workshops, Crystal Application Consultancy, Troubleshooting, and Technical Assessments. These can take place either on customers' premises or at Swarovski

locations. The focus is always on customers' individual needs, the efficient use of Swarovski products, and on the quality of the crystal application.

Our services have been created to take advantage of our comprehensive crystal

application expertise in the following areas: mastery of the relevant techniques, technical knowledge of Swarovski products, process-engineering competencies, and our experience of crystal application equipment, together with our product manufacturing knowledge of various industries.



SERVICE RESULTS (dependent on the particular individual service package):

Prevention of increased development costs through technical input in:

- The correct choice of Swarovski products
- The correct technical design
- The correct application technique
- The correct integration of an application process into the entire process landscape
- Application process set-up

Prevention of cost complaints through technical input in:

- The correct positioning and arrangement of Swarovski products
- Learning how to check the quality of crystal applications
- Suitability of the customer's equipment and tools

Prevention of increased staff development costs through:

- Staff training in appropriate application techniques
- Building your technical knowledge base, thereby enabling you to be self-sufficient

APPLICATION PARTNER NETWORK

As a company with a global sales network and deep understanding of the market, Swarovski has comprehensive knowledge of various application companies and their services from around the world.

Based on this knowledge, Swarovski has developed a global Application Partner Network. These partners offer a wide range of technical and product-related services, as well as tailored production solutions. In order to qualify and to get access to the Application Partner Network,

certain criteria with regard to application techniques, know-how as well as product assortment need to be fulfilled by the application partners.

Application partners can assist you with a variety of application techniques, such as gluing, Hotfix application, sewing, laser cutting of Synthetics, and mechanical application. In addition, many partners can carry out technically complex solutions, such as Flat Back Leather, jewelry manufacturing,

and the automated, mechanical application of products such as Rivets. The services offered by our partners range from product and design consultancy, to prototyping and carrying out production, and make up a key component of our customer focus.

If you are interested in becoming a partner or you need to find a partner, the "Application Partner Platform" on SWAROVSKI-PROFESSIONAL.COM or your local Swarovski office offer guidance.

SWAROVSKI PRODUCTS AND SUITABLE APPLICATION TECHNIQUES

		Soldering	Stone Setting	Plating	Gluing with additional adhesive system	Gluing Self-adhesive Elements	Ceralun	Hotfix Application	Sewing	Embroidery	Hand Application	Mechanical Application
Round Stones			✓		✓		✓					
Fancy Stones & Settings	Fancy Stones		✓		✓		✓					
	Settings ¹	✓	✓	✓	✓				✓ ²		✓	
Beads									✓ ²		✓	
BeCharmed & Pavé	BeCharmed Beads & Pavé Balls								✓ ²		✓	
	BeCharmed Rondelles, Charms & Pavé Pendants								✓ ²		✓	
Crystal Pearls					✓		✓		✓ ²		✓	
Pendants					✓				✓ ²		✓	
Flat Backs No Hotfix			✓		✓		✓					
Flat Backs Hotfix	XILION Rose & XIRIUS Rose							✓				
	Framed Flat Backs							✓				
	Creation Stones							✓				
	Creation Stones Plus							✓				
	Cabochons & Framed Cabochons							✓				
Sew-on Articles	Sew-on Stones								✓		✓	
	Lochrose								✓	✓	✓	
Self-adhesive Elements	Crystal-it Infinity, Crystal Fabric-it, Crystaltex-it, Crystaltex Chaton-it, Crystal Rocks-it, Crystal Fine Rocks-it, Crystal Ultrafine Rocks-it					✓						
	Crystal Fabric Coldfix, Crystal Fine Rocks Coldfix					✓						

1 Settings with hole: suitable for soldering, plating, sewing, hand application; Settings without hole: suitable for soldering and plating.

Closed Setting with ring on top (C-version): suitable for gluing.

2 These products should be sewn by hand.

		Soldering	Stone Setting	Plating	Gluing with additional adhesive system	Gluing Self-adhesive Elements	Ceralun	Hoffix Application	Sewing	Embroidery	Hand Application	Mechanical Application
Transfers	XILION Transfers & XIRIUS Transfers							✓				
	Creation Transfers							✓				
	Creation Transfers Plus							✓				
	Mezzo Transfers							✓				
	Cabochon Transfers							✓				
	Crystal Diamond Transfers							✓				
	Framed Flat Back Transfers & Framed Cabochon Transfers							✓				
Synthetics Hoffix	Crystal Fabric				✓			✓				
	Crystal Rocks, Crystal Fine Rocks & Crystal Ultrafine Rocks				✓			✓				
	Graphic Fabric, Graphic Rocks, Graphic Fine Rocks, Graphic Ultrafine Rocks				✓			✓				
	Crystal Galuchat				✓			✓				
	Crystal Medley				✓			✓				
	Crystaltex				✓			✓	✓ ¹			
Plastic Trimmings	Basic Bandings				✓				✓	✓ ²		
	Mini Rondelles										✓	
Crystal Buttons									✓		✓	
Metal Trimmings	Flat Back Bandings / Motifs				✓				✓			
	Rivets, Square Rivets, Star Rivet, Spike Rivets											✓
	Rose & Chaton Montées								✓ ³		✓	
	Rose Pins											✓
	3D Studs											✓
Crystal Mesh					✓			✓	✓ ⁴			
Cupchains & Findings		✓		✓					✓		✓	

1 Not suitable for Crystaltex Chaton Bandings

2 Art. 50 002, 50 003, and 50 004 (single-row)

3 These products should be sewn by hand.

4 Crystal Fine Mesh has a very tight structure and should therefore be sewn by hand.

GENERAL PRODUCT INFORMATION

This list offers an overview of Swarovski products that are suitable for the application methods described. Product categories/descriptions are based on the 2018 Collection.

Round Stones	Round Stones are loose crystal elements. Most of them are pointed on the reverse side, making them easy to apply in either metal claw settings or pre-set cavities. The assortment features a wide variety of different cuts, the most innovative one being the XIRIUS Chaton and the smallest one being the XERO Chaton in size PPO.
Fancy Stones & Settings	Fancy Stones are offered in numerous shapes ranging from classical gemstone-inspired cuts to progressive trend cuts. They come in a huge assortment of different sizes and colors. Showing either a faceted or flat reverse side, Fancy Stones can be glued into pre-cast cavities or used in metal settings. Their precision-cut facets ensure the highest brilliance and endow design ideas with a unique sparkle.
Beads	Beads offer the highest standard available on the market. The high-quality precision cutting and the clear through-hole achieve high brilliance and clarity. Rounded hole edges reduce the wear on thread and increase the durability of designs. The assortment is divided into classic, romantic, and progressive shape characteristics. They are available in the latest fashion colors, effects, and cuts.
BeCharmed & Pavé	The BeCharmed assortment, from Beads, Crystal Pearls, Pavé, and Rondelles, to Stoppers and Pavé Balls in a brilliant array of colors and effects, offers unlimited combination possibilities. All products of this unique line feature a high-quality stainless steel part with Swarovski branding and a 4.5 mm-diameter hole, which is the standard size for existing charm concepts, making BeCharmed pieces ideal collectibles.
Crystal Pearls	Crystal Pearls are perfect replicas of genuine pearls. They are made of a unique crystal core covered with an innovative pearl coating, which features a flawless, silky smooth, rounded surface. They are available in a variety of shapes, sizes, and colors and are delivered loosely threaded or, if desired, also knotted.
Pendants	Pendants have timeless elegance and are available in a large range of classical and avant-garde cuts and shapes, as well as in many colors and effects. Pendants offer a whole range of design possibilities for different segments thanks to their easy application, with the hole on top requiring only a jump ring/pinch bail with a chain or cord.
Flat Backs No Hotfix	Flat Backs No Hotfix are loose crystal elements backed with platinum foiling for extra brilliance and protection. These Flat Backs are easy to apply to a variety of carrier materials using standard one- or two-component glues. They are available in a multitude of sizes, colors, shapes, and cuts.
Flat Backs Hotfix	Flat Backs Hotfix are loose crystal elements with a flat reverse side that has been pre-coated with a heat-sensitive glue. These Flat Backs can be easily applied to a large range of textile carrier materials using heat to produce a durable and long-lasting crystal effect. Flat Backs Hotfix are available in a multitude of colors, shapes, and cuts.
Sew-on Articles	Sew-on articles are loose crystals that can be easily sewn (either by hand, or with a standard domestic or industrial embroidery sewing machine) onto any type of textile or accessory. Sew-on articles come in two-hole varieties, including round, oval, and triangle holes for use in a wide range of decorative applications for fine embroidery or even jewelry. Lochrosen are crystals with just one hole. Sew-on articles have rounded edges on the hole entry and exit areas to guarantee thread protection.
Self-adhesive Elements	Self-adhesive Elements such as Crystal-it Infinity, Crystal Fabric-it, Crystal-tex-it, Crystal-tex Chaton-it, Crystal Rocks-it, Crystal Fine Rocks-it, Crystal Ultrafine Rocks-it, Crystal Fabric Coldfix or Crystal Fine Rocks Coldfix are eye-catching and innovative products that come ready-to-apply. They are pressure-sensitive and self-adhesive. When applied to a carrier material, they can create elegant, romantic, or sporty designs.

Transfers	Transfers are ideal for Hotfix application on various kinds of textiles. They are available in a large range of motifs and numbers of rows, which are made up of different articles from the Flat Back Hotfix assortment. Featuring designs from our in-house design team, they can include XIRIUS and XILION Roses, or Creation Stones, as well as Cabochons.
Synthetics	These versatile products open up a multitude of creative design possibilities through their numerous application techniques. They combine elegant crystals from Swarovski that can be applied using Hotfix technology with synthetic carrier materials. They are ideal for use in the textile, interior design, jewelry, and accessories segments. Synthetic Coldfix is a product developed especially for materials that are not suitable for Hotfix application.
Plastic Trimmings	Plastic Trimmings are plastic carrier materials with integrated crystals. These multi-functional products can either be hand- or machine-sewn, or glued onto various surfaces. The range of bandings not only offers a color selection of chatons, but also a variety of casing colors.
Crystal Buttons	Crystal Buttons can be used in exactly the same way as standard buttons. The assortment of button usage ranges from shirts, blouses, jackets, and coats, through to denim and accessories. They are suitable for hand application and sewing with a machine.
Metal Trimmings	Metal Trimmings are forward-integrated metal products. They can be sewn by hand or machine and mechanically applied onto different fabrics or other materials. Metal Trimmings are bestsellers among the textile, shoe, and accessories segments because their wide range of application possibilities ensures that they can be used in a multitude of different ways.
Crystal Mesh	Crystal Mesh is a flexible metal mesh carrier with integrated loose crystals. The product is available in a wide range of colors and casings, either as a Hotfix version, which can be applied using heat, or as a No Hotfix version that can be hand- or machine-sewn.
Cupchains & Findings	These products are metal chains and findings that can incorporate either Round or Fancy Stones into any creative design. They can be divided into seven sub-categories: Single Stone Settings, Cupchains and Brass Components, Multi Stone Settings, Channels, Rondelles, and Linked Findings. Each of these categories is available in a wide variety of shapes, sizes, colors, and platings.

CRYSTAL SPECIFICATIONS

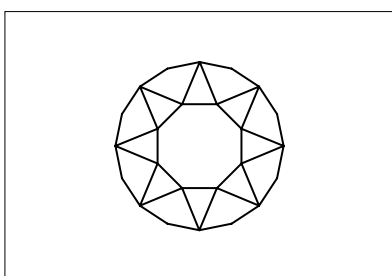

Front view

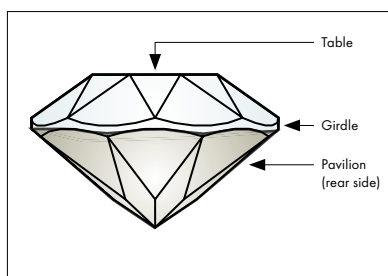

Side view

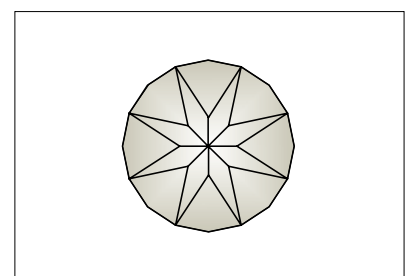

Rear view (Pavilion)

FOILING

Foiling is the process of mirror coating the reverse side of the crystals.



Silver Foiling (A)

A silver mirror finish for XIRIUS and XILION Hotfix articles only.



Platinum* Pro Foiling (F)

A silver mirror finish that is coated with a platinum colored protective layer of highest quality. The Platinum Pro Foiling is not only resistant to environmental damage from chlorine, salt water, and perfume - it can also withstand processes such as soldering and electroplating, giving it unprecedented durability (e.g. art. 4120).



Aluminum Foiling (M)

An aluminum mirror finish is applied using a vacuum coating process (e.g. art. 2855 Flat Back HF).



Protective Layer (P) for Beads and Pendants

Protective layer is a transparent lacquer system that is applied over the effects. This lacquer is designed to protect the effects from scratches, fingerprints, and other damage and also helps to prevent moisture that can lead to corrosion (e.g. from perspiration) penetrating into the effect layer when jewelry is designed to incorporate Crystal Stones that are not set in casings/settings.



Unfoiled (U)

EFFECTS

Vacuum Coating Effects

Vacuum coating processes on the surface of the crystal produce either a special surface or a translucent effect, according to the application methods used.

Please find below a list of all Swarovski effects followed by an explanation of the special vacuum coating processes.

Surface Effects

(Vacuum coating on the surface of the crystal)



Effect Code	Name
AB	Aurore Boreale
ANTP	Antique Pink
API	Astral Pink
BLSH	Blue Shade
BRSH	Bronze Shade
CAL	Comet Argent Light
COP	Copper
DOR	Dorado
GSHA	Golden Shadow
HEM	Hematite (only on Jet)
IRIG	Iridescent Green
LISH	Lilac Shadow
LTCH	Light Chrome
LUMG	Luminous Green
METBL	Metallic Blue
METSH	Metallic Sunshine
MLGLD	Metallic Light Gold
MOL	Moonlight
NUT	Nut (only on Jet)
PARSH	Paradise Shine
RABDK	Rainbow Dark

REDM	Red Magma
ROGL	Rose Gold
SAT	Satin
SCGR	Scarabæus Green designed by JPG
SHIM	Shimmer
SSHA	Silver Shade
TRA	Transmission

Translucent Effects

(Vacuum coating on the reverse side of the crystal, effect shines through the transparent crystal)



Effect Code	Name
BBL	Bermuda Blue
HEL	Heliotrope
MBL	Meridian Blue
SINI	Silver Night
VL	Vitrail Light
VM	Vitrail Medium
VOL	Volcano

Patina Effects

(Partial coating of the correspondingly modified effects)

Effect Code	Name
BLAPA	Black Patina
GOLPA	Gold Patina
ROSPA	Rose Patina
SILPA	Silver Patina
WHIPA	White Patina

Shimmer Effects

<i>Effect Code</i>	<i>Name</i>
001 SHIM	Crystal Shimmer
203 SHIM	Topaz Shimmer
204 SHIM	Amethyst Shimmer
208 SHIM	Siam Shimmer
211 SHIM	Light Sapphire Shimmer
214 SHIM	Peridot Shimmer
215 SHIM	Black Diamond Shimmer
226 SHIM	Light Topaz Shimmer
227 SHIM	Light Siam Shimmer
229 SHIM	Blue Zircon Shimmer
236 SHIM	Hyacinth Shimmer
246 SHIM	Light Colorado Topaz Shimmer
249 SHIM	Citrine Shimmer
259 SHIM	Tangerine Shimmer
360 SHIM	Erinite Shimmer
369 SHIM	Cobalt Shimmer
391 SHIM	Silk Shimmer
502 SHIM	Fuchsia Shimmer

Crystal Lacquer^{PRO} Effects

A premium opaque varnish which is applied to the reverse side of the crystal instead of foiling, resulting in an opalescent appearance.

Crystal Lacquer^{PRO} Powder Effects

<i>Effect Code</i>	<i>Name</i>
001 L101	Crystal Powder Yellow
001 L102	Crystal Powder Green
001 L103	Crystal Powder Rose
001 L104	Crystal Powder Blue
001 L105	Crystal Powder Grey

Crystal Shiny Lacquer^{PRO} Effects

<i>Effect Code</i>	<i>Name</i>
001 L106S	Crystal Ivory Cream
001 L107S	Crystal Royal Red
001 L108S	Crystal Dark Red
001 L109S	Crystal Royal Green
001 L110S	Crystal Royal Blue
001 L111S	Crystal Dark Grey
001 L112S	Crystal Azure Blue
001 L113S	Crystal Peony Pink
001 L114S	Crystal Summer Blue
001 L115S	Crystal Mint Green
001 L116S	Crystal Light Coral

Crystal Lacquer^{PRO} DeLite Effects

<i>Effect Code</i>	<i>Name</i>
001 L129D	Crystal Light Grey DeLite
001 L130D	Crystal Army Green DeLite
001 L131D	Crystal Ochre DeLite
001 L132D	Crystal Burgundy DeLite
001 L133D	Crystal Cappuccino DeLite

Variations on Surface Effects**2x**

Both sides of the stone are treated with an effect (e.g. art. 5328 AB 2x).

**B**

Effects on three sides of a cube shape (e.g. art. 5601 AB B).

**V**

The effect is used in reverse. A surface effect is used like a translucent effect (e.g. art. 2420 NoHF SSHA V - Silver Shade on the reverse side).

**Z**

Only a part of the stone is treated with an effect (e.g. art. 4869 HEL Z).

FC (Full Coated)

Improved technology allows for the perfectly homogeneous, all-round application of high-intensity metallic effects in the Bead assortment (art. 5000).

CAL'V'SI & CAL'VZ'SI

The effect CAL (Comet Argent Light) is also used as a mirror coating on the reverse side of the crystal instead of standard foilings (A, F, ...) in special cases (e.g. art. 2035).

/G

Article with partly (PF) or fully frosted (FF) surface (e.g. art. 2611/G).

Special Surface Effects



























































Swarovski has been able to achieve special surface effects by using special chemical and mechanical processes on the surface of the crystals.



<i>Effect Code</i>	<i>Name</i>
MAT	Matt Finish

The Matt Finish effect is achieved by performing a chemical matting process on the entire surface of the crystal. Small variations in the size of the articles may occur as a result of this chemical process.

COLORS

 Crystal 001	 Fuchsia 502	 Capri Blue 243	 Olivine 228
 White Opal 234	 Ruby 501	 <u>Majestic Blue</u> ¹ 296	 <u>Greige</u> 284
 Light Silk 261	 Siam 208	 Montana 207	 <u>Light Grey Opal</u> 383
 Silk 391	 Burgundy 515	 Light Turquoise 263	 Light Colorado Topaz 246
 Light Peach 362	 Amethyst 204	 Blue Zircon 229	 Jonquil 213
 Rose Water Opal 395	 Tanzanite 539	 Indicolite 379	 <u>Yellow Opal</u> 231
 Vintage Rose 319	 Violet 371	 <u>Indian Sapphire</u> 217	 Light Topaz 226
 <u>Blush Rose</u> 257	 Light Amethyst 212	 <u>Denim Blue</u> 266	 Topaz 203
 Light Rose 223	 <u>Smoky Mauve</u> 265	 Black Diamond 215	 <u>Tangerine</u> 259
 <u>Rose Peach</u> 262	 Provence Lavender 283	 Pacific Opal 390	 Light Smoked Topaz 221
 Padparadscha 542	 Light Sapphire 211	 Chrysolite 238	 Smoked Topaz 220
 Light Siam 227	 Light Azure 361	 Peridot 214	 <u>Smoky Quartz</u> 225
 <u>Scarlet</u> 276	 Aquamarine 202	 Erinite 360	 <u>Graphite</u> 253
 <u>Indian Siam</u> ² 327	 Air Blue Opal 285	 Fern Green 291	 Jet 280
 Rose 209	 Sapphire 206	 Emerald 205	

GENERAL PRODUCT INFORMATION

The here presented colors and effects are based on the Round Stone color chart. For details on available colors and effects for each article within the product groups, please see the product matrix of the respective item in the Collection 2018.

For color and effect samples, please see the corresponding color chart.

The plating resistance of effects is tested according to Swarovski's plating guidelines (SWAROVSKI-PROFESSIONAL.COM). Customers are advised to carry out their own tests if customers' plating parameters diverge from Swarovski plating guidelines.

* Crystals are not resistant to plating and similar processing.

** Crystals are resistant to plating only if they are F-foiled.

*** designed by Jean Paul Gaultier.

¹ Majestic Blue's intense ultramarine hue is difficult to recreate accurately in print due to the fact that the CMYK color spectrum is used in the printing process. In order to get a truer impression of its color, please use RGB digital pictures or, ideally, ask for actual samples.

² The color Indian Siam is available only for a specific size range. Please refer to the current Collection.

Classic Colors/Effects: This color range offers a wide choice of traditional Swarovski crystal colors and effects.

Exclusive Colors/Effects: This color range is offered exclusively by Swarovski.

Colors and effects can appear different when illuminated with different light sources. Swarovski uses standard light source D50 for color decision and comparison. Slight changes in shades are unavoidable. Colors may vary according to cut and foiling.

The composition of Advanced Crystal is compliant with regulatory industry norms and laws regarding the restriction or prohibition of certain substances in the most relevant segments of our customers. Please note that the compliance of the crystal colors Citrine, Fireopal, Hyacinth, Light Siam, Siam, and Yellow Opal varies according to certain industry regulations. Those regulations are indicated with * in the compliance overview. Indian Siam and Scarlet (option to Lt. Siam) conform to all CLEAR-lists.

For further information please visit SWAROVSKI-PROFESSIONAL.COM

© 2018 D. Swarovski Distribution GmbH

EFFECTS

-  Crystal Silver Shade
001 SSHA
-  Crystal Moonlight
001 MOL
-  Crystal Aurore Boreale
001 AB
-  Crystal Luminous Green*
001 LUMG
-  Crystal Golden Shadow
001 GSHA
-  Crystal Metallic Sunshine*
001 METSH
-  Crystal Rose Gold*
001 ROGL
-  Crystal Astral Pink
001 API
-  Crystal Antique Pink*
001 ANTP
-  Crystal Vitrail Light**
001 VL
-  Crystal Paradise Shine*
001 PARSH
-  Crystal Vitrail Medium**
001 VM
-  Crystal Bermuda Blue**
001 BBL
-  Crystal Metallic Blue*
001 METBL
-  Crystal Blue Shade*
001 BLSH
-  Crystal Scarabaeus Green*/***
001 SCGR
-  Crystal Rainbow Dark*
001 RABDK
-  Crystal Dorado*
001 DOR
-  Crystal Metallic Light Gold*
001 MLGLD
-  Crystal Light Chrome*
001 LTCH
-  Crystal Comet Argent Light*
001 CAL
-  Crystal Silver Night**
001 SINI
-  Jet Hematite*
280 HEM

CRYSTAL LACQUER^{PRO}
EFFECTSCrystal Lacquer^{PRO} Powder
Effects

-  Crystal Powder Yellow*
001 L101
-  Crystal Powder Rose*
001 L103
-  Crystal Powder Blue*
001 L104
-  Crystal Powder Green*
001 L102
-  Crystal Powder Grey*
001 L105

Crystal Shiny Lacquer^{PRO}
Effects

-  Crystal Ivory Cream*
001 L106S
-  Crystal Light Coral*
001 L116S
-  Crystal Royal Red*
001 L107S
-  Crystal Peony Pink*
001 L113S
-  Crystal Dark Red*
001 L108S
-  Crystal Lilac*
001 L126S
-  Crystal Summer Blue*
001 L114S
-  Crystal Royal Blue*
001 L110S
-  Crystal Azure Blue*
001 L112S
-  Crystal Mint Green*
001 L115S
-  Crystal Royal Green*
001 L109S
-  Crystal Lime*
001 L125S
-  Crystal Buttercup*
001 L124S
-  Crystal Dark Grey*
001 L111S







Crystal Lacquer^{PRO} DeLite
Effects

-  Crystal Light Grey DeLite*
001 L129D
-  Crystal Burgundy DeLite*
001 L132D
-  Crystal Army Green DeLite*
001 L130D
-  Crystal Ochre DeLite*
001 L131D
-  Crystal Cappuccino DeLite*
001 L133D

CRYSTAL PATINA
EFFECTS

-  Crystal White Patina
001 WHIPA
-  Crystal Rose Patina*
001 ROSPA
-  Crystal Silver Patina*
001 SILPA
-  Crystal Gold Patina*
001 GOLPA
-  Crystal Black Patina*
001 BLAPA

SHIMMER EFFECTS

-  Light Siam Shimmer
227 SHIM
-  Light Sapphire Shimmer
211 SHIM
-  Black Diamond Shimmer
215 SHIM
-  Erinite Shimmer
360 SHIM
-  Light Colorado Topaz Shimmer
246 SHIM
-  Light Topaz Shimmer
226 SHIM

SIZES

•	PP 0 0.70-0.80 mm	•	PP 23 (SS 11) 2.90-3.00 mm	•	SS 30 6.32-6.50 mm	•	SS 47 10.54-10.91 mm
•	PP 1 (SS 000) 0.80-0.90 mm	•	PP 24 (SS 12) 3.00-3.20 mm	•	SS 31 6.50-6.68 mm		
•	PP 2 (SS 00) 0.90-1.00 mm	•	PP 25 (SS 13) 3.20-3.30 mm	•	SS 32 6.68-6.87 mm	•	SS 48 10.91-11.30 mm
•	PP 3 (SS 0) 1.00-1.10 mm	•	PP 26 (SS 13) 3.30-3.40 mm	•	SS 33 6.87-7.07 mm		
•	PP 4 (SS 1) 1.10-1.20 mm	•	PP 27 (SS 14) 3.40-3.50 mm	•	SS 34 7.07-7.27 mm	•	SS 49 11.30-11.72 mm
•	PP 5 (SS 2) 1.20-1.30 mm	•	PP 28 (SS 14) 3.50-3.60 mm	•	SS 35 7.27-7.48 mm		
•	PP 6 (SS 2) 1.30-1.35 mm	•	PP 29 (SS 15) 3.60-3.70 mm	•	SS 36 7.48-7.70 mm	•	SS 50 11.72-11.97 mm
•	PP 7 (SS 3) 1.35-1.40 mm	•	PP 30 (SS 15) 3.70-3.80 mm	•	SS 37 7.70-7.93 mm		
•	PP 8 (SS 3) 1.40-1.50 mm	•	PP 31 (SS 16) 3.80-4.00 mm	•	SS 38 7.93-8.16 mm	•	SS 55 12.97-13.22 mm
•	PP 9 (SS 4) 1.50-1.60 mm	•	PP 32 (SS 17) 4.00-4.10 mm	•	SS 39 8.16-8.41 mm		
•	PP 10 (SS 4) 1.60-1.70 mm	•	PP 33 (SS 17) 4.10-4.20 mm	•	SS 40 8.41-8.67 mm	•	SS 60 14.22-14.47 mm
•	PP 11 (SS 5) 1.70-1.80 mm	•	SS 18 4.20-4.40 mm	•	SS 41 8.67-8.95 mm		
•	PP 12 (SS 5) 1.80-1.90 mm	•	SS 19 4.40-4.60 mm	•	SS 42 8.95-9.23 mm	•	SS 65 15.47-15.72 mm
•	PP 13 (SS 6) 1.90-2.00 mm	•	SS 20 4.60-4.80 mm	•	SS 43 9.23-9.53 mm		
•	PP 14 (SS 6) 2.00-2.10 mm	•	SS 21 4.80-4.90 mm	•	SS 44 9.53-9.85 mm	•	SS 70 16.72-16.97 mm
•	PP 15 (SS 7) 2.10-2.20 mm	•	SS 22 4.90-5.10 mm	•	SS 45 9.85-10.19 mm		
•	PP 16 (SS 7) 2.20-2.30 mm	•	SS 23 5.10-5.27 mm	•	SS 46 10.19-10.54 mm	•	SS 75 17.97-18.22 mm
•	PP 17 (SS 8) 2.30-2.40 mm	•	SS 24 5.27-5.44 mm				
•	PP 18 (SS 8) 2.40-2.50 mm	•	SS 25 5.44-5.61 mm				
•	PP 19 (SS 9) 2.50-2.60 mm	•	SS 26 5.61-5.78 mm				
•	PP 20 (SS 9) 2.60-2.70 mm	•	SS 27 5.78-5.96 mm				
•	PP 21 (SS 10) 2.70-2.80 mm	•	SS 28 5.96-6.14 mm				
•	PP 22 (SS 10) 2.80-2.90 mm	•	SS 29 6.14-6.32 mm				

GENERAL PRODUCT INFORMATION

Various measurement abbreviations are used to classify the jewelry stones.



PP, SS

Pearl Plate (PP), Sieve Size or Stone Size (SS) for round crystals.

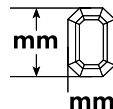

mm

Metric figures in millimeters for crystal components and geometric forms.



2

SOLDERING, STONE SETTING, AND PLATING

Swarovski offers an ideal product selection for soldering, allowing for simple and problem-free production of state-of-the-art jewelry pieces and accessories. Further techniques such as stone setting and plating complement the comprehensive and diverse application options offered by Swarovski.

- 24** Product Overview
- 24** Machines and Tools
- 26** Suppliers
- 27** Application
- 38** Useful Information
- 40** Quick Assistance

PRODUCT OVERVIEW

The following products are suitable for soldering, stone setting, and plating:

	SOLDERING ²	STONE SETTING	PLATING ²
Round Stones		✓	
Fancy Stones		✓	
Settings ¹	✓	✓	✓
Flat Backs No Hoflix		✓	
Cupchains & Findings	✓		✓

1 As per February 2017, the new base material for Swarovski Settings is tombac (alloy: CuZn15, according to DIN EN 10204).

2 It is recommended to use the unplated version (Z) of Settings, Cupchains, and Findings.

MACHINES AND TOOLS

The following machines, tools and aids can be used for soldering Swarovski crystals:



Micro soldering kit



Propane gas burner



Blow torch



Solder wire

It is recommended that solder wire with a flux core is used, which guarantees an even flow of solder.



Solder paste

Solder paste containing flux must be applied at exactly the right spot to create a clean solder joint.



Solder pellets

Solder pellets should be placed in an acid flux before being used. This ensures that the solder will flow correctly.



Soldering molds

J-board, express cement, impression material, putty



Polishing machine



Unset Cupchain hand prong setting tool

This interchangeable unset Cupchain hand prong setting tool is an easy way to set any 6 mm, 8.5 mm, 10 mm, 11 mm, or 12 mm crystals into empty Cupchain settings or jewelry settings.



Gloves



Protective eyewear

SUPPLIERS

This list provides an overview of selected suppliers worldwide.

MACHINES & TOOLS	SUPPLIER	CONTACT
Micro soldering kit	Horbach Rio Grande	www.horbach-giesstechnik.de www.riogrande.com
Propane gas burner	Horbach Rio Grande	www.horbach-giesstechnik.de www.riogrande.com
Blow torch	Rio Grande Siegfried Remschnig SRA Soldering Products	www.riogrande.com www.remschnig.at www.sra-solder.com
Solder wire	Alpha Ögussa Rio Grande SRA Soldering Products	www.alpha.alent.com www.oegussa.at www.riogrande.com www.sra-solder.com
Soldering paste	Alpha Ögussa Rio Grande SRA Soldering Products	www.alpha.alent.com www.oegussa.at www.riogrande.com www.sra-solder.com
Solder pellets	Ögussa Rio Grande SRA Soldering Products	www.oegussa.at www.riogrande.com www.sra-solder.com
Flux	Alpha Ögussa Rio Grande SRA Soldering Products	www.alpha.alent.com www.oegussa.at www.riogrande.com www.sra-solder.com
J-board (solder mold)	SRA Soldering Products	www.sra-solder.com
Impression material / (dental) putty	3M	www.3m.com
Unset cupchain hand prong setting tool	Canonicus Epoxy Plus Inc.	gracecabral@verision.net
Settings	Swarovski E.H. Ashley & Company, Inc. Franz Simm Metall- und Zinkdruckgusswaren GmbH Josef Berghs GmbH & Co. KG Rio Grande	www.swarovski-professional.com www.ehashley.com www.simm-metallwaren.de www.josef-berghs.de www.riogrande.com

APPLICATION

SOLDER MOLD PRODUCTION

A solder mold is required to reproduce jewelry pieces. First the original model of the jewelry piece is soldered. This is then used to make an impression in a suitable

impression material (J-board, express cement). Depending on the size of the jewelry piece and mold medium, this impression can be made several times.



1 Solder the original model.



2 Strengthen the rear of the original model with wire.



3 Press the original model into a suitable impression material.



4 Once the material hardens, the original model can be removed.

Note: The solder mold must be designed in such a way that hardly any pressure is needed to position the Cupchain segment into the mold. The crystals may be damaged if there are high levels of mechanical stress on the cups, or if they are deformed.

SOLDERING PREPARATION

Materials and tools should be clean, and particularly **free of any grease**, to ensure proper application. When soldering and plating, adequate ventilation is essential.

In addition, it is recommended that protective clothing, protective eyewear and protective gloves are worn in line with the manufacturer's safety information sheets.

Wearing protective gloves also prevents tools from getting dirty.

SELECTING THE OPTIMUM SOLDER AND FLUX

When selecting solder, the working temperatures and flow characteristics are particularly important. Solder is available

from various manufacturers in wire form, with or without a flux core, as a paste and as pellets.

Note: Only soldering alloys with a working temperature up to 280 °C (536 °F) should be used for soldering Cupchains. The higher the working temperature of the solder material used, the more precise workmanship and exact temperature control are necessary to avoid damaging the crystal and the foiling.

When soldering Cupchains, solder wire with a flux core is more suitable. If solder pellets are being processed, or the wire used does not have a flux core, the flux should be adapted according to the solder manufacturer's instructions, while any corrosive effects on the foiling should be

checked via pre-testing. These effects should be assessed after plating, as damage done during soldering is often only visible at this point.

For soldering Cupchains we suggest using one of the following lead-free solder wires:

NAME	COMPOSITION	MELTING RANGE	SUPPLIER
Envirosafe	96.5% Sn, 3.45% Cu, 1% Sb, 0.05% Ag	215 - 220 °C 419 - 428 °F	www.sra-solder.com
Silox 227	99% Sn, 1% Cu	227 °C 440 °F	www.oegussa.at

SOLDERING

SOLDERING TIME AND TEMPERATURE

The right flame size and the time it is applied are important criteria when manufacturing soldered Cupchain pieces. The size of the flame must comply with the instructions for

use provided by the tool's supplier. Only heat the part of the jewelry piece in which the solder should flow. If the flame is held too long on the jewelry piece, the piece and

the crystals may become overheated and therefore damaged or destroyed.

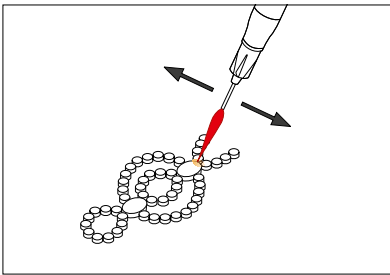

Note: A sudden drop in temperature after the soldering process should be avoided (e.g. shock cooling), as this could damage the crystal (e.g. chipping).

COLOR DURING SOLDERING



1 Optimum temperature



2 Too high temperature

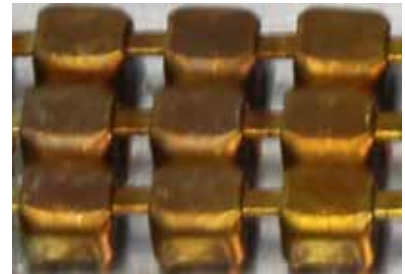

3 Too low temperature

COLOR AFTER SOLDERING



1 Optimum temperature



2 Too high temperature

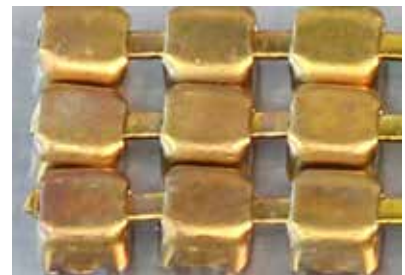

3 Too low temperature

OPTIMUM SOLDERING JOINT

The width of the joint to be soldered should be between 0.05 mm and 0.2 mm. If the joint is wider than 0.2 mm, the solder will

not fill the joint sufficiently. A joint that is too narrow will also not contain enough solder to make it strong and neat.

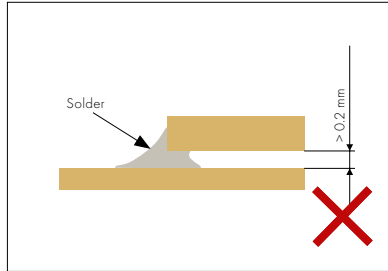
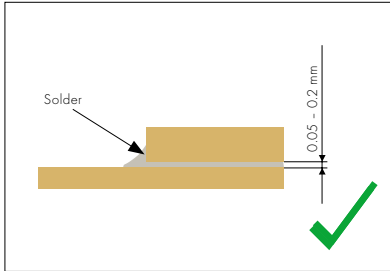

OPTIMUM SOLDER QUANTITY

The right amount of solder ensures strong and clean soldered joints, which can then be cleanly plated. Correctly applied solder flows into the joints of the jewelry piece and

provides a strong connection. Either too much or too little solder can damage the creations or result in unwanted discoloring of the crystal.

APPLICATION

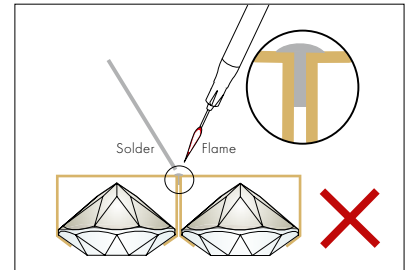
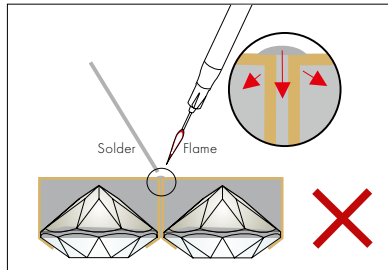
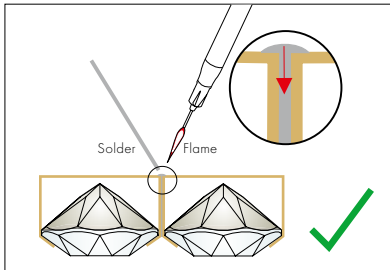

Exact amount of solder

The solder is drawn into the solder gap via capillary action.



Too much solder

Too much solder results in the cup back-filling, with the hot solder damaging the foiling. This damage creates a corroding surface following plating, and the foiling is destroyed. As such, these types of soldering errors are only really visible after plating.



Too little solder

Too little solder means the soldering gap is not completely filled, and the joint is weakened.

SOLDER MOLD
PRODUCTIONSOLDERING
PREPARATION

SOLDERING

STONE SETTING

CLEANING

PLATING

SOLDERING



1 Cut the Cupchain to the required length.



2 Put the Cupchain in the solder mold.



3 Solder the required spots.



4 Remove the soldered Cupchain from the mold.

SOLDER MOLD
PRODUCTIONSOLDERING
PREPARATION

SOLDERING

STONE SETTING

CLEANING

PLATING

STONE SETTING

Stone setting is the art of securely setting or attaching crystals into jewelry by creating positive-locking connections. Alongside the application methods outlined in this manual, Swarovski products can also be employed using metal settings. Crystals can be set manually (using pliers, metal spatulas, or punching tools) or by machine.

According to how the crystals are integrated into the metal settings, there are various types of settings, both plated and unplated. Whenever possible, the crystals should be set before plating the settings. The Swarovski assortment features products like Cupchains that have already been set, as well as Settings for Fancy Stones. Crystals

can be set after plating as well, depending on the shape and geometry of the jewelry. Please be aware that a selected range of Swarovski crystals cannot be plated. For further information on this, please see the current Swarovski Crystal Collection.

SETTING TYPES



Bezel settings

With bezel settings, the crystals are bezelled in to remain in the cup.

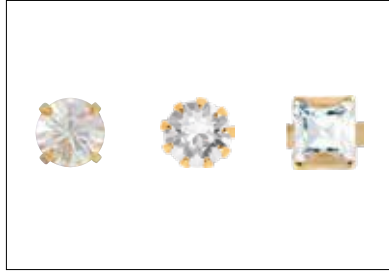

Prong settings

With prong settings, Swarovski crystals are held in position by claws. In most cases there are four prongs. Settings with flaps have significantly broader claws. The advantage here is that the broader claws are much less likely to damage very sensitive carrier material.

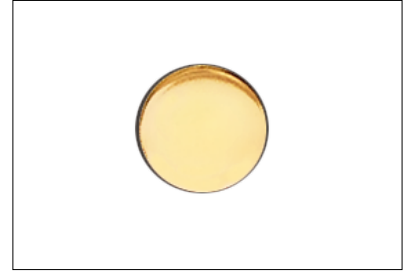

Settings for gluing

In this type of setting (crystal) elements are glued in.

SETTING BY HAND

1. Depending on the shape and size, the cup is held using tweezers, flat nose pliers, or flat head pliers, without deforming it.
2. Place the crystal in the setting using a pair of tweezers or vacuum tweezers.

3a. Bezel setting: Press the cup shut using a setting closer. Setting closers are available from jewelry suppliers.

3b. Prong setting: The prongs of round cups can be pressed in place using a suitable setting closer. For all other forms, the prongs are individually closed

in opposite positions, using a suitable pressing tool. For a faster setting of crystals in Cupchains, the unset Cupchain hand prong setting tool can be helpful: place the tool over the top of the prongs. By pushing down the tool, the prongs roll over the crystal.

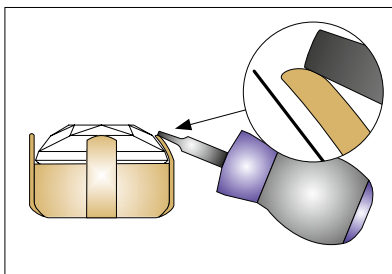

Prong settings

Note: After setting, the crystal should still be slightly movable in the setting. The setting must be constructed so that the crystal can



Unset Cupchain hand prong setting tool

be positioned into it without damaging the foiling. When settings are too tight or prongs are bent, the foiling or the protective

lacquering can be damaged, possibly resulting in corrosion. If the setting is closed too strongly, the crystal can be damaged.

APPLICATION METHODS FOR SET CRYSTALS

The following application possibilities are available for already set crystals:

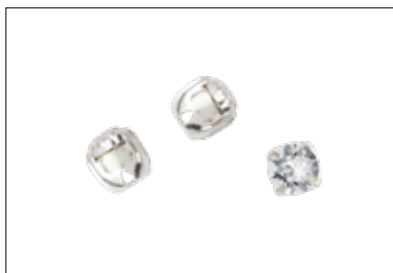

Sewing

Sew-on cups are applied by sewing onto textiles and leather. There are holes in the cups for the thread to pass through.



Soldering

These types of settings are suitable for soldering with other cups and/or with Cupchains. They are mostly used in the jewelry segment.



Mechanical application

With this special type of setting, the set crystal is applied onto the textile using claws. For more information please consult the corresponding chapter.



Threading

Settings that can be used as a pendant have an eyelet at the top, to which a chain can be attached. Settings with two eyelets can be attached to other elements.

WORKING WITH END CONNECTORS (BRASS COMPONENTS)

Plated Cupchains and Findings can easily be combined with end connectors (brass components) in order to create striking pieces of jewelry.



APPLICATION

The end connectors can be attached to the end of the Cupchain with flat-nosed pliers and interconnected by either jump rings or lobster claws.

CRYSTAL APPLICATION INSTRUCTION MOVIE

Attaching end fasteners

Watch instruction movie for further insights on how to properly work with end fasteners online at <http://swarovski.com/cupchain-application>



CLEANING

To avoid corrosion, soldered items should be cleaned as soon as possible after the soldering process. This will make the plating process significantly easier. Care must be taken when using mechanical polishing devices. Polishing media that are

too hard or drums that rotate too quickly can damage the items and the crystals. Check the quantity, the polishing agents and time, the rotating speed, and the height of the fall, in order to keep mechanical stress levels as low as possible. In order to

preserve the high quality of the creations, we recommend not using organic solvents and not exceeding a maximum temperature of 100 °C (212 °F).

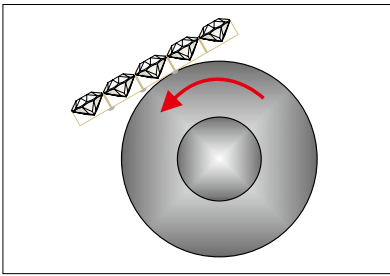

Removal of excessive solder alloy by polishing

PLATING

Plating serves to finish the jewelry piece. During this process, metallic coatings are electrolytically added to the surface of the material. The process can only be carried out if the material to be plated is conductive. During the design process, please ensure that individual colors and coating effects can withstand plating. For further information, please see the color overview in the current Swarovski Crystal Collection.

When plating items including crystals following **criteria are essential to avoid a chemical and/or mechanical damage to crystals** and to achieve an excellent finishing process:

- **no strong alkaline and cyanide solutions**
- **short exposure times in alkaline baths**
- **moderate ultrasonic cleaning**
- **moderate current densities**
- selecting reliable electrolyte suppliers who offer good service and who can provide detailed operating instructions
- selecting suitable high performance electrolytes
- careful maintenance of the unit and the electrolytes

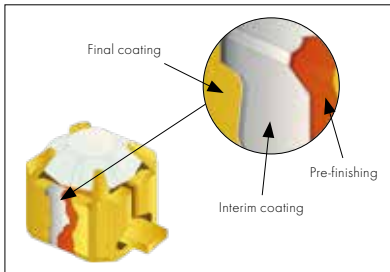

SHORT DESCRIPTIONS OF THE PROCESSING STEPS

- **Soak Cleaning:** Here, most of the surface pollution (e.g. dirt, grease, soldering flux) is removed.
- **Electrolytic degreasing:** Only cathodic degreasing, suitable for brass and non-ferrous metals, is recommended for fine cleaning Cupchain jewelry.
- **Acid Dip:** This part of the process serves to remove oxidization from the metal and also the remains of any scale left from the soldering process.
- **Cyanide copper plating:** This processing step serves to improve adhesive strength and conductivity.
- **Pyrophosphate copper plating:** Like cyanide copper plating, this process improves adhesive strength and conductivity. The advantage is that the process does not involve cyanide, though the disadvantage is that higher current densities and longer exposure times are required.
- **Bright copper plating:** The use of sulfuric bright copper plating is recommended because of its excellent ability to cover surface flaws and create an even finish.
- **Palladium coating:** Palladium is presently the only recommended replacement for nickel since the bronze electrolytes currently available on the market can, through their extreme alkalinity, lead to damage of the foiling.
- **Silver coating:** Shiny silver coatings are usually separated from cyanide solutions that contain alkali silver (I)-cyanide, alkali cyanide, alkali carbonate, and organic and/or inorganic additives.
- **Gold coating:** It is recommended to use phosphorus or citric acid electrolytes (pH ~ 3 - 4), which contain potassium gold (I)-cyanide.
- **Rhodium coating:** Sulfur or phosphoric acid based electrolytes are used for rhodium plating, from which shining, nearly silver-white layers can be applied.
- **Tarnish protection**
 - **Temporary protection against tarnishing:** These are based either on wax mixtures in organic solvents or long-chained sulfuric organic compounds, which can be used as wet-on-wet aqueous emulsions.
 - **Permanent tarnishing protection systems:** Cathaphoretic lacquering systems have been proven especially effective as a longer lasting protective system for Cupchain jewelry. They have the advantage over conventional dipping and spray lacquers based on acrylic or zapon varnish (cellulose lacquer) in that only the conductive surfaces are very evenly coated while the isolated facets of the crystals remain uncoated.

EXAMPLE OF A PLATING PROCESS FOR CUPCHAINS

PREPARATION

Setting up the stand	
Soak Cleaning	$t < 5 \text{ min}$, $\text{pH} < 12.5$, $T < 55 \text{ }^\circ\text{C}$ (131 °F)
Rinsing	$t < 30 \text{ sec}$, $T < 25 \text{ }^\circ\text{C}$ (77 °F)

PRE-FINISHING

Electrolytic degreasing	$t < 15 - 20 \text{ sec}$, 3 A/dm^2 , $\text{pH} < 12.0$, $T < 45 \text{ }^\circ\text{C}$ (113 °F)
Rinsing	$t < 30 \text{ sec}$, $T < 25 \text{ }^\circ\text{C}$ (77 °F)
Acid Dip	$t = 15 - 20 \text{ sec}$, $\text{pH} < 1$
Rinsing	$t < 30 \text{ sec}$, $T < 25 \text{ }^\circ\text{C}$ (77 °F)

Cyanide copper plating	$t = 1 \text{ min}$, 2 A/dm^2 , $\text{pH} < 10.5$, $T = 60 \text{ }^\circ\text{C}$ (140 °F)	Pyrophosphate copper plating	$t = 3 \text{ min}$, 1 A/dm^2 , $\text{pH} = 9.2$, $T = 55 \text{ }^\circ\text{C}$ (130 °F)
Rinsing	$t < 30 \text{ sec}$, $T < 25 \text{ }^\circ\text{C}$ (77 °F)	Bright copper plating	$t = 5 - 6 \text{ min}$, 3 A/dm^2 , $\text{pH} < 1$, RT

INTERIM COATING

Palladium	$t = 1 - 2 \text{ min}$, 1 A/dm^2 , $\text{pH} = 8 - 9$, $T = 25 - 30 \text{ }^\circ\text{C}$ (77 - 86 °F)	Silver	$t < 1 \text{ min}$, 2 A/dm^2 , $\text{pH} < 12.0$, RT
Rinsing	$t < 30 \text{ sec}$, $T < 25 \text{ }^\circ\text{C}$ (77 °F)	Rinsing	$t < 30 \text{ sec}$, $T < 25 \text{ }^\circ\text{C}$ (77 °F)

FINAL COATING

Rhodium	$t = 1 \text{ min}$, 1 A/dm^2	Gold	$t = 1 \text{ min}$, 1 A/dm^2	Tarnish protection	$t < 30 \text{ sec}$, $T < 25 \text{ }^\circ\text{C}$ (77 °F)
Rinsing	$t < 30 \text{ sec}$, $T < 25 \text{ }^\circ\text{C}$ (77 °F)	Rinsing	$t < 30 \text{ sec}$, $T < 25 \text{ }^\circ\text{C}$ (77 °F)	Hot rinsing and drying	$t = 30 \text{ sec}$, $T = 50 \text{ }^\circ\text{C}$ (122 °F)
Hot rinsing and drying	$t = 30 \text{ sec}$, $T = 50 \text{ }^\circ\text{C}$ (122 °F)	Hot rinsing and drying	$t = 30 \text{ sec}$, $T = 50 \text{ }^\circ\text{C}$ (122 °F)		

AN ADDITIONAL EFFECT OR PROTECTIVE LACQUERING CAN ALSO BE APPLIED.

USEFUL INFORMATION

This section offers a brief overview of the ways in which Swarovski products can be integrated into jewelry design

software, and a summary of the two most important production techniques for jewelry: rubber mold and lost wax.

JEWELRY DESIGN SOFTWARE

Leading software manufacturers offer special programs with three-dimensional display possibilities for the design of jewelry and accessories. These 3D-design programs feature a whole range of functions that simplify and support the design process

and therefore also the entire production process. Special software solutions that have integrated a range of digitally processed Swarovski crystals in their programs are already available (www.3design.com).

These can be simply and quickly integrated into any design, thus allowing the designer to work with Swarovski crystals right from the beginning of the design phase.

RUBBER MOLD PROCESS IN JEWELRY MANUFACTURING

This process is widely used in the production of fashion jewelry. Tin alloys are mostly used here, and the biggest

advantage of this procedure is the favorable price of the required tools.



1 Several original models are shaped out of metal, which must already exhibit an excellent surface quality. The expected shrinkage during casting must be taken into account.



2 These original models are pressed into a rubber mold. The rubber mold gets vulcanized to create a rubber casting model.



3 Channels are cut in the rubber plate for the casting process.



4 The completed rubber molds are pressed together and filled with the molten metal alloy during rotation (centrifugal casting procedure).



5 After cooling and removing from the mold, the casting channels are cut off.



6 The cast model achieved by this process is ground and polished in preparation for the plating process.

LOST WAX PROCESS IN JEWELRY MANUFACTURING

The lost wax process is used for metals with a higher melting point, for example brass, silver, and gold.



1 Production of a prototype, e.g. through rapid prototyping; the better the surface quality is here, the better the casing will be later. The expected shrinkage during casting must be taken into account.



2 The prototype is either formed with silicone or vulcanized between raw rubber plates.



3 The already produced mold is injected with molten wax by a wax injector to create a wax model.



4 The wax forms created this way are each melted onto a wax tree format with a wax welding device. The trunk of the wax tree later serves as the casting channel.



5 The tree is now placed into a cuvette, the holes are glued up and it is embedded in implantation paste under vacuum and vibration.



6 The wax is melted out after the implantation paste has hardened. Remaining wax is burnt out in a kiln. The wax must be completely burnt out, leaving only the clean cavities.



7 While it is still hot, the cuvette is filled, under vacuum, with the molten metal. Because of the porosity of the form, the molten metal fills every part of it.



8 After casting, the hot cuvette is plunged into cold water. The casting tree is then cleaned.



9 After the jewelry pieces are removed from the casting tree, they are finished by grinding and polishing and pre-treated for the galvanization process.

QUICK ASSISTANCE

The following table outlines typical soldering, stone setting and plating problems, along with possible causes and recommendations on avoiding them.

PROBLEM	CAUSE
Metal components:	
The solder joints crack.	1, 2, 3, 4
The jewelry piece has restricted movement.	2, 5
The metal surface is defective.	2, 6
The metal surface is uneven.	7
Defective finishing on the soldered areas.	8
Corrosion occurs on the metal.	9
Crystal:	
The crystal chips off.	10, 11, 12, 13
The crystal becomes discolored.	14, 15, 16, 17

CAUSE	RECOMMENDATION
1 Too little solder is used. This weakens the solder joint, as the soldering gap is not completely filled.	Use more solder.
2 Too much solder is used. A large solder joint can result in cracks, because any force applied to the piece directly affects the solder.	Use less solder, especially in the areas close to the moving parts. Too much solder at these parts restrict their flexibility.
3 The flow of the solder is insufficient.	The following factors contribute to a sufficient flow of solder: <ul style="list-style-type: none"> – The flame needs to be strong enough so that both solder and cup can heat up to the required working temperature. – To make sure the flux cannot vaporize, the soldering temperature must not exceed 280 °C (536 °F). A vaporized flux means that the solder is not able to cover the metal surface. – The melting temperature of the solder must not be higher than 280 °C (536 °F).
4 The metal surface, solder, flux, or solder mold is dirty.	Special attention must be paid to use clean (and above all grease-free) metal surfaces.
5 Exposure to the finishing process has been too long.	The exposure time for functional and flexible elements should be kept as short as possible. Optimizing the polishing processes and the use of high quality electrolytes is also recommended.
6 Insufficient cleaning after soldering.	Incorrect cleaning has a negative impact on the finishing process. Carefully check the cleaning process.
7 Poor quality of polishing. The metal surface shows irregularities like burns or an orange color.	Carefully polish the product and take care that the processor plating baths are set up correctly.

CAUSE	RECOMMENDATION
<p>8 Unsightly finishing on the solder areas can have several causes:</p> <ul style="list-style-type: none"> – incorrect soldering – insufficient cleaning after the soldering process – the use of sulfuric acid in the pickling process (if lead-containing solder has been used) – the absence of or incorrect use of copper plating 	Carefully follow the soldering steps described in this chapter.
<p>9 Insufficient rinsing or using contaminated rinsing water can cause tarnishing or corrosion.</p>	The transfer times between the individual stages of the process should be kept as short as possible. Rapid tarnishing of silver can be prevented by using effective tarnishing protective systems (e.g. coatings, wax, lacquer etc.).
<p>10 Poor quality of solder mold.</p>	The solder mold must be designed in such a way that hardly any pressure is needed to position the Cupchain segment into the mold. The crystals may be damaged if there are high levels of mechanical stress on the cups, or if the cups are deformed.
<p>11 Thermal shock during the soldering or cooling process can cause tension in the crystals.</p>	Avoid extreme differences in temperature during and after the soldering and cooling process.
<p>12 When using polishing drums, the surface of the crystals can be damaged through hard polishing components in the rotating machine.</p>	Mechanical stress levels should be kept as low as possible. Check the quantity of articles used, the polishing agents and time, as well as the rotating speed and the height of the fall.
<p>13 Using barrel plating can damage crystals in heavy or sharp Cupchains due to the Cupchains' size or shape.</p>	In general it is recommended that Cupchain jewelry should be finished on a plating rack. If using a barrel plating, choose the best type of drum and optimize the rotation and the fall height. When the drum is between the different stages of the finishing process and contains no liquid, the items being plated inside the drum may damage each other.
<p>14 The soldering temperature is too high.</p>	If the soldering flame is too strong or the soldering times are too long, there is the danger to overheat the solder joints. This can damage the crystals. It can be helpful using a solder that melts at a lower temperature.
<p>15 Too much solder is in the cups. This can damage the crystals' foiling and subsequently leads to discoloring.</p>	To make sure the right amount of solder is used, remove one crystal from the cup. If there is any solder left in the cup, reduce the amount of solder. This can be achieved by using a solder wire with a maximum diameter of 1 mm or by reducing the time the solder is in contact with the cups.
<p>16 Incorrect cleaning with ultrasonic can damage the foiling of the crystals.</p>	Take care not to use the ultrasonic too intensively or for too long time.
<p>17 Faults occurred during the finishing process.</p>	Check the alkalinity, current density, exposure times, and temperatures of the plating baths used. Further mistakes could be incorrect rinsing and post processing techniques.



3

GLUING

Swarovski products can be glued to a wide range of materials in a variety of application areas. The greatest quality is ensured by following the entire application process.

44	Product Overview
44	Machines and Tools
48	Suppliers
50	Application
73	Useful Information
77	Quick Assistance

PRODUCT OVERVIEW

The following products are suitable for gluing:

	GLUING WITH ADDITIONAL ADHESIVE SYSTEM
Round Stones	✓
Fancy Stones	✓
Settings	✓
Crystal Pearls	✓
Pendants	✓
Flat Backs No Hotfix	✓
Self-adhesive Elements	- *
Synthetics	✓
Plastic Trimmings: Basic Bandings	✓ **
Metal Trimmings: Flat Back Bandings/Motifs	✓
Crystal Mesh	✓

* See separate chapter Self-adhesive Elements

** Plastic Trimmings made of PE or PP are not suitable for gluing.

MACHINES AND TOOLS

The following machines, tools and aids can be used for the various processes involved in gluing Swarovski products:



CNC milling machine



Box column drill



Hand drill

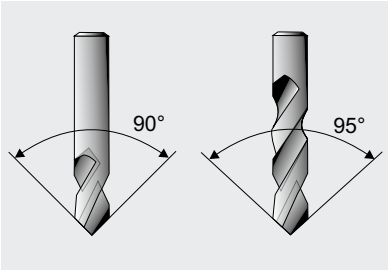

**Twist drill 90°/
NC drill 90°
for
XILION Chatons**

**Twist drill 95°/
NC drill 95°
for
XIRIUS Chatons**

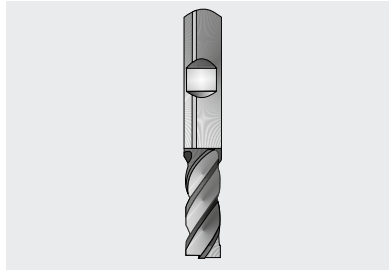

Milling cutter



Test Pen (art. 9030/000)



Isopropyl alcohol/Acetone



Blow torch



Corona



Plasma cleaner



Precision balance



Plastic gloves



Protective eyewear



Dispensing robot



Fluid dispenser

Courtesy of I&J Fisnar, Inc.



Dispensing gun



Dispensing syringes with dispensing tips



Mixing Nozzle (art. 9030/126)



CG 500 (A+B)

Two-component epoxy resin glue: 50 ml cartridge (25 ml resin + 25 ml hardener)



CG 500 (A+B)

Two-component epoxy resin glue: 100 ml tube (50 ml resin + 50 ml hardener)



CG 500 (A+B)

Two-component epoxy resin glue: 2 l box (1 l resin + 1 l hardener)



CG 610 (A+B)

Two-component epoxy resin glue: 50 ml cartridge (33.3 ml resin + 16.7 ml hardener)



CG 610 (A+B)

Two-component epoxy resin glue: 750 ml box (500 ml resin + 250 ml hardener)



Different glues



Chaton Sieve for Chatons size PP 0 - PP 1 (art. 9030/003)



Chaton Sieve for Chatons size PP 2 - PP 20 (art. 9030/001)



Chaton Sieve for Chatons size PP 21 - SS 34 (art. 9030/002)



Vacuum pump with silicone hose (art. 9040/022), can be adapted to a pick-up system by attaching a dispensing tip (to be ordered separately).



Tweezers



Wax stick



UV light



Drying oven

SUPPLIERS

This list provides an overview of selected suppliers worldwide.

MACHINES & TOOLS	SUPPLIER	CONTACT
90°/95° NC drill/milling cutter	Dixi Holding SA Hahn & Kolb GmbH Hoffmann GmbH Reich Präzisionswerkzeuge Wedco	www.dixi.ch www.hahn-kolb.de www.hoffmann-group.com www.reich.at www.wedco.at
Test Pen	Swarovski: art. 9030/000	www.swarovski-professional.com
Fluid dispenser (with/without vacuum suction)	Epoxy & Equipment Technology Pte Ltd Hottemp (M) Sdn. Bhd. I & J Fisnar, Inc. Vieweg GmbH	www.eet.com.sg www.hottemp.com.my www.fisnar.com www.dosieren.de
Mixing Nozzle for CG 500 (A+B) and CG 610 (A+B) (10 pcs.)	Swarovski: art. 9030/126	www.swarovski-professional.com
CG 500 (A+B) Two-component epoxy resin glue	Swarovski: art. 9030, CG 500 (A+B) 50 ml cartridge, Asia, Europe/America art. 9030, CG 500 (A+B) 100 ml tube, Asia, Europe/America art. 9030, CG 500 (A+B) 2 l box, Asia, Europe/America	www.swarovski-professional.com
CG 610 (A+B) Two-component epoxy resin glue	Swarovski: art. 9030, CG 610 (A+B) 50 ml cartridge, Asia, Europe/America art. 9030, CG 610 (A+B) 750 ml box, Asia, Europe/America	www.swarovski-professional.com
Araldite® adhesives	Bodo Möller Chemie GmbH	www.bm-chemie.com
3M™ Scotch-Weld™ adhesives	3M	www.3m.com
DELO adhesives	DELO Industrial Adhesives	www.delo.de
Elastosil® adhesives / MS Clear HS	Wacker Chemie AG	www.wacker.com
Loctite® adhesives	Henkel Ltd.	www.loctite.com
C. Kreul Hobby Line Schmuckstein Kleber	C. KREUL GmbH & Co KG	www.c-kreul.com
CHRISANNE glues	Chrisanne Ltd	www.chrisanne.com
Bostik 1475	Bostik SA	www.bostik.com
UHU plus endfest 300	UHU GmbH & Co KG	www.uhu.com
Tile glues / joint sealers	PCI Augsburg GmbH KERAKOLL Spa ARDEX GmbH	www.pci-augsburg.de www.kerakoll.com www.ardex.com
RBC adhesive 2K	RBC Industries, Inc.	www.rbcepoxy.com

MACHINES & TOOLS	SUPPLIER	CONTACT
Chaton Sieve	Swarovski: For Chatons size PP 0 - PP 1: art. 9030/003 For Chatons size PP 2 - PP 20: art. 9030/001 For Chatons size PP 21 - SS 34: art. 9030/002	www.swarovski-professional.com
Vacuum pump with silicone hose, can be adapted to a pick-up system by attaching a dispensing tip	Swarovski: art. 9040/022	www.swarovski-professional.com
Vacuum pick-up system	Epoxy & Equipment Technology Pte Ltd I & J Fisnar, Inc.	www.eet.com.sg www.fisnar.com
Pick-up stick	Crystal Ninja	www.crystalkatana.com
Dispensing gun	Vieweg GmbH Perigee Direct	www.dosieren.de www.epoxysupply.com
Dispensing tip for adapting a vacuum pump	Gonano Dosiertechnik GmbH Vieweg GmbH	www.dosieren.net www.dosieren.de
UV light	DELO Industrial Adhesives Dr. Hönle AG Heraeus Holding GmbH Herbert Waldmann GmbH & Co. KG	www.delo.de www.hoenle.de www.heraeus.com www.waldmann.com
Drying oven	Heraeus Holding GmbH VWR International, LLC.	www.heraeus.com www.vwr.com

APPLICATION

When gluing Swarovski crystals, optimal results are obtained by **coordinating the entire application process**. Following the application steps in the right order is very

important. Experience has shown that the most common reasons for crystals becoming detached are inappropriate areas of application, poorly produced cavities, unsuitable gluing systems, and

insufficient quantities of glue. **Product-specific application instructions** are detailed later in this section.

CAVITY PRODUCTION

Many Swarovski crystals require cavities in order to be applied to materials. A properly produced cavity in combination with a suitable gluing system ensures a stylish, long-lasting application. The cavity

makes it easy to glue properly and ensures higher **protection of the crystal against mechanical and chemical stress**.

There are several different production methods and cavity types. Always take

into consideration the requirements and base material of the finished product when choosing the appropriate cavity, pre-treatment method, and kind of glue.

PRODUCTION METHODS

- **Drilling** is when materials are machined using a power drill and drilling tool.
- **Milling** is when materials are machined using a milling machine and milling cutter. Milling machines can be fitted with appropriate tools depending on the materials, e.g. for working with metal and plastic, wood, or natural stone. Modern CNC machining centers offer the greatest precision and can be used to produce **cavities of every shape** necessary. Please note that when machining natural stone, ceramic, or glass, for example, special diamond-tipped tools must be used.
- **Water jet cutting** allows materials to be separated via a high-pressure jet of water. Economic reasons make water jet cutting machines ideal for certain crystal shapes that are integrated into flat materials. Please note that only **end-to-end cavities** can be produced in this way. In addition, materials that swell through water cannot be worked with. Absorbent materials must be fully dried before gluing the crystal.
- **Casting:** To reproduce cavities, particularly in the jewelry sector, the cavities can be made when the metal component is cast. When following this process, the cavities must be cut into the original model. To prevent the bottom of the cavity being rounded off, which would result in the crystal sitting too high, it is recommended that an additional indentation is made when producing the original model. Further instructions on jewelry production can be found on page 38.

CAVITY PRODUCTION

CHECKING SURFACE
TENSION AND
PRE-TREATMENT

CHOICE OF GLUE

DOSAGE AND SETTING

POST-CLEANING
AND CURING

CAVITY TYPES

Depending on the Swarovski products used, various cavity types can be made using the different production methods.

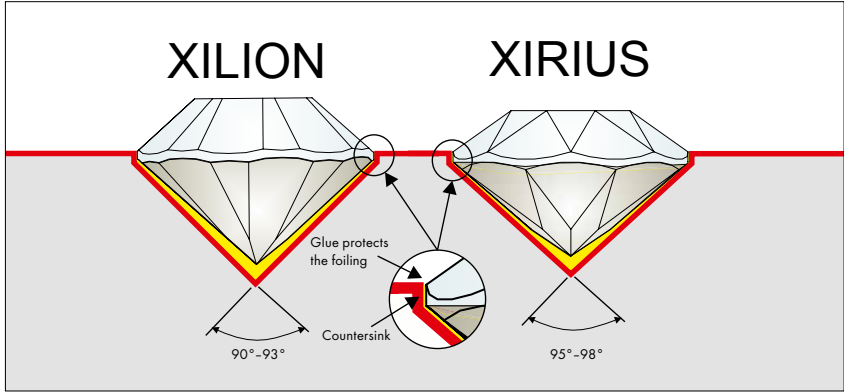
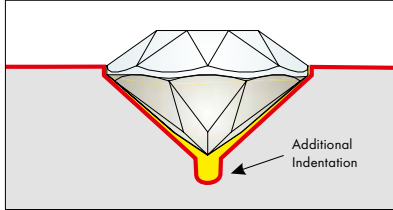
SWAROVSKI PRODUCTS	PRODUCTION METHOD	CAVITY TYPE
Round Stones	Drilling Milling	<p>Chaton cavity</p>  <p>The optimal cavity for a XIRIUS Chaton is produced at an angle of 95° – 98°, for a XILION Chaton at 90° – 93°. The cavity should have the same maximum diameter as the crystal plus at least 0.1 mm. The stone sizes available for Swarovski crystals can be found on page 20. For particularly large crystals with a prominent girdle, it is advisable to use an additional countersinking process. Please find a cavity calculator on SWAROVSKI-PROFESSIONAL.COM.</p>
Round Stones	Casting	<p>Chaton casting cavity</p>  <p>For jewelry manufactured by casting, an additional indentation at the bottom of the cavity can be drilled to avoid a rounded tip, therefore preventing the crystal from being raised out of the cavity.</p>

CAVITY PRODUCTION

CHECKING SURFACE TENSION AND PRE-TREATMENT

CHOICE OF GLUE

DOSAGE AND SETTING

POST-CLEANING AND CURING

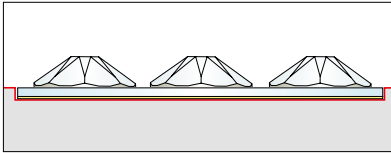
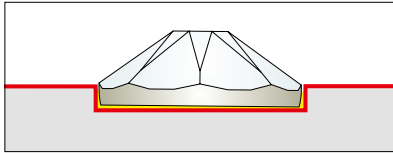
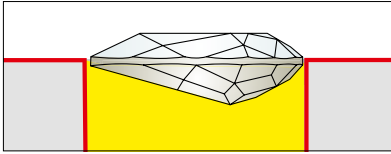
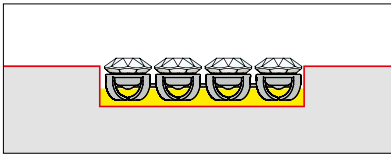
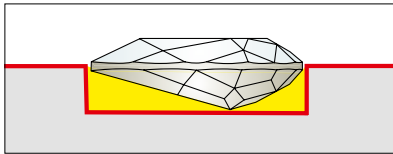
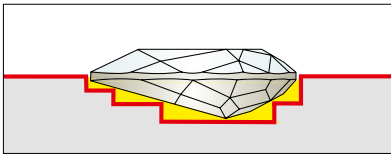
SWAROVSKI PRODUCTS	PRODUCTION METHOD	CAVITY TYPE		
Flat Backs No Hotfix Crystal Fabric Crystaltex Self-adhesive Elements* Crystal Rocks Crystal Fine Rocks Crystal Ultrafine Rocks	Milling Casting	Indentation		
<p>When gluing an article with a flat back it is also advisable to create a cavity as shown here. This cavity ensures that the crystal is better protected against mechanical and chemical stress. The depth of the cavity depends on the height of the girdle and the thickness of the base material.</p>				
Round Stones Flat Backs No Hotfix Fancy Stones	Drilling Milling Water jet cutting	End-to-end cavity		
<p>An end-to-end cavity is the simplest option when producing cavities. When selecting the glue (page 57), please note the additional instructions regarding the gluing gap.</p>				
Plastic Trimmings Crystal Mesh Fancy Stones	Milling Casting	Blind hole		
<p>A blind hole is another option when producing cavities. It allows Swarovski crystals in a variety of heights to be set and protected in the material. When selecting the depth of the cavity, ensure that there is still a gap between the lowest point of the crystal and the base material. When selecting the glue (page 57), please note the additional instructions regarding the gluing gap.</p>				
Fancy Stones	Milling Casting	Step milling		
<p>Compared to a simple blind hole, step milling offers better hold of the crystal with less glue. When selecting the depth of the cavity, ensure that there is still a gap between the lowest point of the crystal and the base material. When selecting the glue (page 57), please note the additional instructions regarding the gluing gap.</p>				

APPLICATION

*except Coldfix

CAVITY PRODUCTION

CHECKING SURFACE TENSION AND PRE-TREATMENT

CHOICE OF GLUE

DOSAGE AND SETTING

POST-CLEANING AND CURING

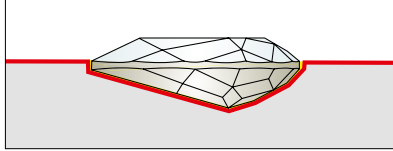
SWAROVSKI PRODUCTS	PRODUCTION METHOD	CAVITY TYPE
Fancy Stones	Milling Casting	<p>3D milling</p>  <p>3D milling offers an optimum fit with the smallest gluing gap. Due to the fact that the cavity is adapted to the contours of the crystal, CNC milling machines are required.</p>

PRODUCTION TOLERANCES FOR CAVITIES

When producing cavities, the dimensions should be based on the main dimensions, including the maximum tolerance for the crystal components used, and the

production tolerance. These dimensions can be requested from your Swarovski sales organization.

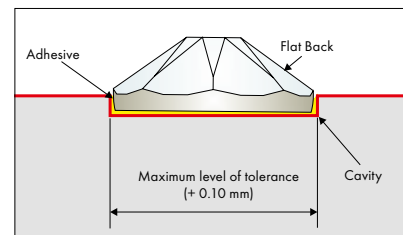

INCORRECT CAVITIES

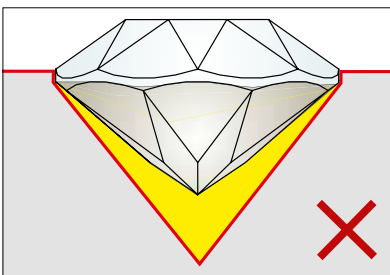

Angle too sharp

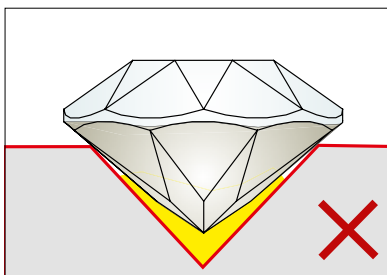

Crystal too large/cavity too small

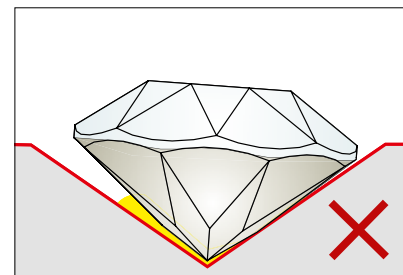

Angle too large

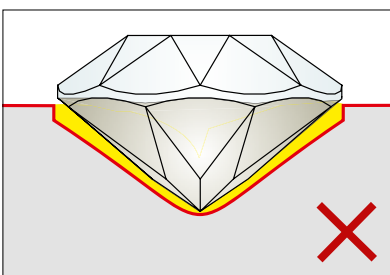

Rounded tip of the cavity

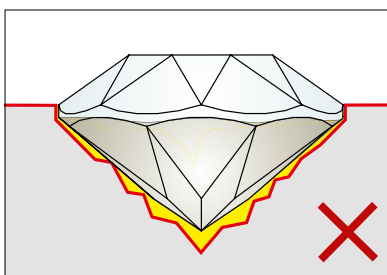

Cavity with uneven surface

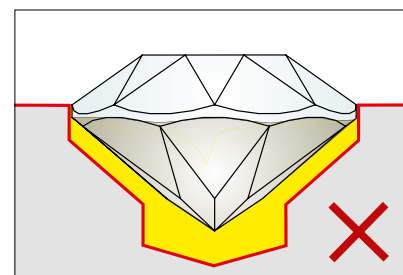

Gap too big

CHECKING SURFACE TENSION AND PRE-TREATMENT

CHECKING THE SURFACE TENSION

The surface tension is an indicator for the wetting properties of the surface to be glued. A surface tension of **at least**

38 mN/m is recommended for gluing Swarovski crystals. It should also be randomly tested during production.

It is best to use the Test Pen (art. 9030/000) to measure the surface tension.



1 Before gluing, mark the surface.



2 If the ink remains visible for 2 seconds, the surface is suitable for gluing.



3 If the ink disappears or forms bubbles, the surface is not suitable for gluing. In this case, the pre-treatment cleaning methods should be checked.

Note: On porous or absorbent materials, the surface tension cannot be checked with the Test Pen. If the Test Pen is used on highly polluted surfaces (e.g. grease, oil) or on material like wood, the Test Pen might be polluted as well and cannot be used anymore.

CRYSTAL APPLICATION INSTRUCTION MOVIE

Checking surface tension

Watch instruction movie on proper Test Pen usage online at <http://swarovs.ki/gluing-application>



PRE-TREATMENT

If the surface tension is below 38 mN/m, the following pre-treatment cleaning methods, applied in the correct order,

can be effective in reaching the right level. After each cleaning process, the surface tension has to be checked again.

CAVITY PRODUCTION

CHECKING SURFACE
TENSION AND
PRE-TREATMENT

CHOICE OF GLUE

DOSAGE AND SETTING

POST-CLEANING
AND CURING**TYPES OF CLEANING****PRE-TREATMENT CLEANING METHODS****1 Mechanical cleaning**

This involves sanding, blasting, or brushing but is usually not necessary for jewelry.

- Removal of dirt, rust, scale, and residues of varnish
- Roughening the surface

2 Washing and degreasing

It is important to ascertain that the tensides do not contain silicone, as this would impair adhesion.

When using solvents it is advisable to test the durability of the surface to be cleaned beforehand to avoid any damage.

Solvents containing substances with a high boiling point should not be used due to the risk of residue. If using cleaning solvents, wait a few minutes to allow them to evaporate.

- Cleaning with tenside solutions, rinsing with de-ionized water
- Cleaning with isopropyl alcohol/ethanol
- Cleaning with acetone (MEK/ethyl acetate)
- Cleaning with a cleaning solvent: should not contain high boiling point substances (risk of residue)

3 Physical cleaning and activation

These cleaning methods can be applied if mechanical cleaning or washing and degreasing are either not possible or have not resulted in a surface tension of >38 mN/m. Therefore the pre-treatment cleaning method used should be done on a case-by-case basis.

- **Flame treatment via a blow torch**
The surface to be treated is exposed to the flame of a torch very briefly. When using special gas mixtures, surface silication can also be carried out, so as to apply a more adhesive coating.
- **Corona treatment**
An electric corona discharge is briefly applied to the surface.
- **Plasma treatment**
Plasma treatment offers precise cleaning and activates the surface via an ionized gas.

4 Chemical cleaning and primers

Applying a primer improves adhesion and helps to prevent corrosion.

- Applying small amounts of solvent and activating the surface.
- Applying a primer.

CAVITY PRODUCTION

CHECKING SURFACE
TENSION AND
PRE-TREATMENT

CHOICE OF GLUE

DOSAGE AND SETTING

POST-CLEANING
AND CURING**CHOICE OF GLUE**

The selection of the best gluing system is the next stage in ensuring a long-lasting application.

When selecting the most suitable glue, the following factors should be considered:

- The type of cavities/the resulting gluing gap
- The size of the crystals/gluing surface
- The gluing properties and finish required
- The type of base material

THE TYPE OF CAVITIES/THE RESULTING GLUING GAP

When selecting an adhesive, it is also important to consider the gluing gap that results from the type of cavity chosen. For cavities offering a **large gluing gap, soft**

and gap-filling glues such as silicone glue are recommended to avoid tension in the glue joint.

Epoxyethane/polyurethane glues offer **greater strength** and can be used for cavities with a **small gluing gap**.

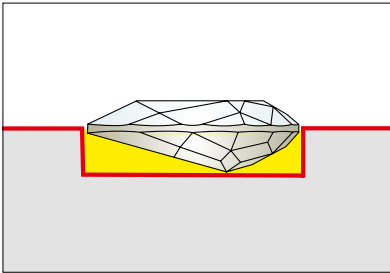

Large gluing gap

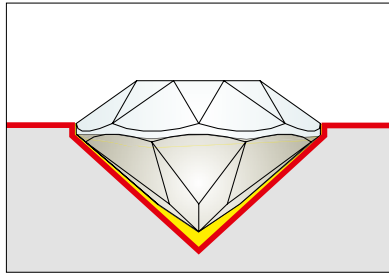

Small gluing gap

APPLICATION

THE SIZE OF THE CRYSTALS/GLUING SURFACE

Please note that when gluing small crystals, glues with higher shearing strengths (e.g. CG 500 (A+B) two-component epoxy glue)

should be used. Further information can be found in the manufacturer's technical data sheets.

THE GLUING PROPERTIES AND FINISH REQUIRED

When selecting glues, it is important to consider properties such as **pot life, viscosity, color, curing time, ease of dosing, and shrinkage**. Further information can be found in the manufacturer's technical data sheets. Adhesives tend to shrink during curing. There will be a greater amount of **shrinkage** if the

wrong glue has been chosen, it is hardened under the wrong conditions, or if there is an incorrectly sized cavity (too much space around the crystal). The tension thus created can damage the foiling and the crystals may even detach. Glues that are very hard after curing and shrink considerably are not suitable for Swarovski crystals with foiling.

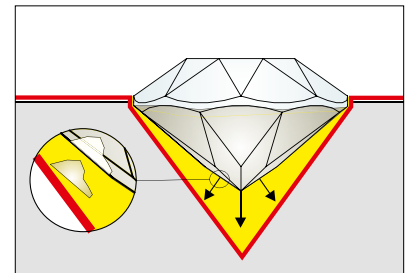

The foiling is torn from the crystal because of excessive glue shrinkage (shown in yellow).

THE TYPE OF BASE MATERIAL

The following table provides a selection of commonly known and globally available adhesives that are suitable for different

uses and materials. Application tests are advisable to make sure the chosen glue fulfills the specific needs of your application.

CAVITY PRODUCTION

CHECKING SURFACE
TENSION AND
PRE-TREATMENT

CHOICE OF GLUE

DOSAGE AND SETTING

POST-CLEANING
AND CURING

Viscosity: Measure of a fluid's resistance to gradual deformation by shear/tensile stress. It corresponds to the informal notion of 'thickness'.

Viscosity types

low	thin fluid
med	medium
high	pasty

Color: Description of the glue's color type after curing.

Bonding: Depending on the carrier material, the bonding of the glues can vary.

Bonding types

+	sufficient or excellent bonding can be reached
o	sufficient bonding is possible
-	sufficient bonding is nearly impossible

	TWO-COMPONENT EPOXY RESIN GLUES								POLYURETHANE GLUES			CYANOACRYLATE GLUES	UV GLUES		SILICONE GLUES	ONE-COMPONENT SYSTEM	DOUBLE SIDED TAPES	DISPERSIONS & CONTACT GLUES				
	CG 500 (A+B)	CG 610 (A+B)	UHU plus endfest 300	Araldite® 2011	RBC adhesive #118 A/B	DELO-DUOPOX AD821	3M™ Scotch-Weld™ DP 190	Araldite® 2028-1	3M™ Scotch-Weld™ DP 610	DELO-PUR 9895	LOCTITE® 401™	DELO-PHOTOBOND GB368	DELO-PHOTOBOND 4494	ELASTOSIL® N 2199	DELO-MONOPOX AD066	3M™	C. Kreul Hobby Line Schmuckstein Kleber	Bostik 1475	CHRISANNE			
Color	translucent	translucent	beige	beige	translucent	beige	white/gray	transparent	transparent	beige	transparent	transparent	transparent	transparent	beige	transparent	transparent	beige	white			
Viscosity	med	low	high	high	med	med	high	low	high	high	low	med	med	high	med	-	med	high	high			
Crystal	+	+	o	+	+	+	+	o	o	o	-	+	+	-	+	o						
Glass	+	+	o	+	+	+	+	o	o	o	-	+	+	-	o	o						
Ceramics	+	+	-	o	+	+	+	+	+	+	-	-	-	o	o	o						
Stone	+	+	-	o	+	+	+	+	+	+	-	-	-	o	o	o						
Aluminum	+	+	+	+	+	+	+	+	+	+	o	+	+	o	+	o						
Brass	+	+	+	+	+	+	+	+	+	+	o	+	+	o	+	o						
Silver	+	+	+	+	+	+	+	+	+	+	o	+	+	o	+	o						
Steel	+	+	+	+	+	+	+	+	+	+	o	+	+	o	+	o						
PC	+	+	-	o	+	+	+	o	o	o	+	o ¹	+	o	-	o						
PS	+	+	-	o	o	+	+	o	o	o	+	o ¹	o ¹	o	-	o						
PVC/ABS	+	o	-	o	+	+	+	o	o	o	+	o ¹	o ¹	o	-	o						
PMMA	+	o	-	o	o	+	+	o	o	o	+	+	o ¹	o	-	o						
Paper	o	o	-	o	+	o	o	o	o	o	o	-	-	o	-	o	o	o	o	o	o	o
Cork	o	o	-	o	+	o	o	o	o	o	-	-	-	o	-	o		o	o	o	o	o
Wood	o	o	-	o	+	o	o	o	o	o	-	-	-	o	-	o		o	o	o	o	o
Textiles ²	-	-	-	-	+	-	-	-	o	-	-	-	-	-	-	-	o	o	o	o	o	o

¹ The second gluing part has to be UV transparent.² For permanent (wash-resistant) application a Hotfix application is suggested.

APPLICATIONS ON PLASTICS

There are many types of synthetic materials. The following table contains information regarding the adhesive qualities of a selection of plastics.

PLASTICS	ADHESIVE QUALITIES
ABS	good
ASA	good
CA	good
EP	good
PA	very difficult
PC	good
PE	difficult
PET	difficult
PF	good
PIB	good
PMMA	good
POM	difficult
PP	difficult
PS	good
PTFE	very difficult
PVC	good
SAN	good
SILICONE	very difficult
UP	good

CAVITY PRODUCTION

CHECKING SURFACE
TENSION AND
PRE-TREATMENT

CHOICE OF GLUE

DOSAGE AND SETTING

POST-CLEANING
AND CURING

CG 500 (A+B) TWO-COMPONENT EPOXY RESIN GLUE

CG 500 (A+B) is a high-performance gluing system for both foiled and unfoiled Swarovski crystals, exclusively distributed by Swarovski for professional use within the jewelry segment and other industries such as accessories, interiors, and electronics.

Key features:

- Ideal mechanical resistance
- Ideal chemical resistance
- Future-oriented solution
- Diverse areas of application

Ideal mechanical resistance

CG 500 (A+B) **absorbs impacts and withstands distortion**. In addition, maximum elasticity protects the crystal foiling.



XILION Chatons that have been glued with CG 500 (A+B) remain in the cavities after extreme mechanical stress due to **optimal shock absorbance** (up to 500%).



XILION Chatons that have been glued with a **standard epoxy resin** fall out of their cavities after extreme mechanical stress due to its **poor shock absorbance** (around 10%).

Ideal chemical resistance

CG 500 (A+B) OFFERS EXCELLENT CHEMICAL RESISTANCE AGAINST:

Humidity	CG 500 (A+B) prevents infiltration of humidity into the glue and thus any corrosion. Jewelry pieces can be stored and worn in places with high humidity.
Perspiration	CG 500 (A+B) prevents infiltration of perspiration into the glue and thus avoids corrosion. The glued Swarovski products are not damaged by perspiration.
Salt and chlorinated water	CG 500 (A+B) protects Swarovski crystals when they are exposed to salt or chlorinated water. The glued Swarovski products are not damaged during swimming.

Diverse areas of application

CG 500 (A+B) OFFERS IDEAL ADHESION FEATURES ON:

Metals	E.g. application of Swarovski products on plated surfaces, brass, stainless steel, titanium, gold, rhodium, and silver within the jewelry industry
Gluable synthetics and rubber	E.g. application of Swarovski crystals on ABS, PMMA, PVC etc. within the accessories and electronics industries
Glass, crystal, wood, stone, cork, and porcelain	E.g. application of Swarovski products in the interior and home décor industries

Technical data of CG 500 (A+B)

Mixture ratio (A : B), by volume	100 : 100 (resin : hardener)
Mixture ratio (A : B), by weight	100 : 86 (resin : hardener)
Pot life at room temperature (23 °C/73.4 °F), quantity applied: 1g	15 min.
Complete curing time at room temperature (23° C/73.4 °F)	24h
Complete curing time in oven (40° C/104 °F)	12h
Complete curing time in oven (80° C/176 °F)	2h
Complete curing time in oven (100° C/212 °F)	1h
Handling time at room temperature (23 °C/73.4 °F)	3h
Viscosity (mixed)	20,000 +/- 5,000 mPa*s

Mixing CG 500 (A+B) two-component glue

The exact mixing of the two-component glue is especially important. Only a fully homogenous mixture leads to the desired results. Care must be taken to follow the manufacturer's instructions.

APPLICATION



- 1** Use an electric scale to weight out the two components at a ratio of 100:86 (resin : hardener).
- 2** Both components come in different color shades so that it is easy to see if they are thoroughly mixed.
- 3** Mix the two components until a homogenous result is achieved.



- 4** Put the glue in a dispenser.
- 5** Attach the dispensing tip to the syringe.

CAVITY PRODUCTION

CHECKING SURFACE
TENSION AND
PRE-TREATMENT

CHOICE OF GLUE

DOSAGE AND SETTING

POST-CLEANING
AND CURING

CRYSTAL APPLICATION INSTRUCTION MOVIE

Mixing two-component adhesive

Watch instruction movie how to mix the tube version of Swarovski Crystal Glue CG 500 online at <http://swarovs.ki/gluing-mixing-two-components>



CG 610 (A+B) TWO-COMPONENT EPOXY RESIN GLUE

The CG 610 (A+B) two-component epoxy resin glue was specially developed for gluing Swarovski crystals of very small sizes, starting with PP 0. Depending on the area of application the adhesive can be used for crystals up to the size of PP 14.

Key Features:

- Suitable for gluing very small crystals (starting with size PP 0)
- Low viscosity allows an easier dosing of small glue quantities
- Cost saving due to long pot life (140 min.)

Technical data of CG 610 (A+B)

Mixture ratio (A : B), by volume	100 : 50 (resin : hardener)
Mixture ratio (A : B), by weight	100 : 48 (resin : hardener)
Pot life at room temperature (23 °C/73.4 °F), quantity applied: 1g	140 min.
Complete curing time at room temperature (23° C/73.4 °F)	72h
Complete curing time in oven (40 °C/104 °F)	18h
Complete curing time in oven (80 °C/176 °F)	4h
Complete curing time in oven (100 °C/212 °F)	1.5h
Handling time at room temperature (23 °C/73.4 °F)	24h
Viscosity (mixed)	1,750 +/- 250 mPa*s

Mixing CG 610 (A+B) two-component glue

The **50 ml cartridge** of CG 610 (A+B) is designed in a way that the containing resin and hardener do not have to be mixed together by the user. Just attach a dispensing gun and the mixing nozzle (delivered with the 50 ml adhesive package) to the cartridge and start gluing.



When using glue of the **750 ml box**, resin and hardener have to be mixed in a different way. First, weigh the two glue components at a ratio of 100 : 48 (resin : hardener). It is very important to keep an exact mixing ratio

of the two components to achieve maximum adhesion. Mix the two components well for at least one minute. Only a fully homogenous mixture leads to the desired results.

When a homogenous mixture is achieved, put the glue into a dispenser/syringe and attach a dispensing tip.



CAVITY PRODUCTION

CHECKING SURFACE
TENSION AND
PRE-TREATMENT

CHOICE OF GLUE

DOSAGE AND SETTING

POST-CLEANING
AND CURING

DOSAGE AND SETTING

DOSAGE

The glue can be precisely dispensed via a variety of dosage systems. Dispensers with a vacuum connection prevent the glue from

dripping and reduce the amount of cleaning needed. The correct amount of glue will additionally protect the foiling from external

influences. Attention must be paid to the application and quantity of the glue.

Glue application

Irrespective of the shape of the gluing area, the glue should be applied as follows:

With a **round** gluing area, a dot of glue in the centre is sufficient. When the crystal is applied, the glue will be evenly distributed in the gluing gap. To glue a single spot, aim the dispensing needle just above the spot to be glued and lift it slowly upward to avoid any glue spreading out sideways.

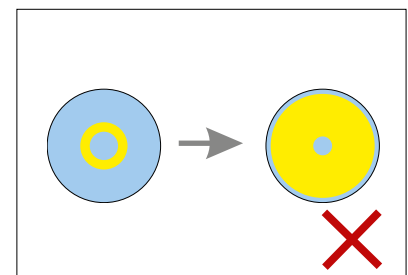
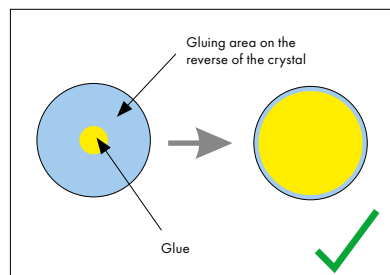

With a **square or rectangular** gluing area, apply a cross of glue to ensure it is evenly spread into the corners.

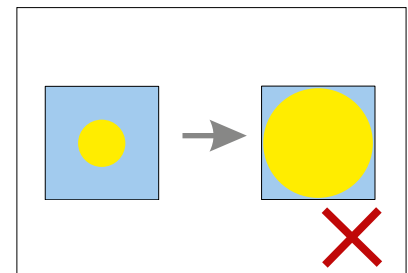
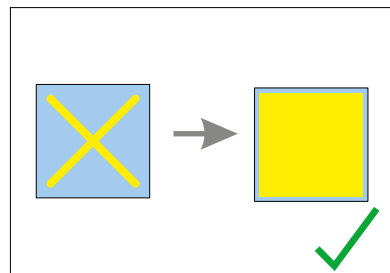

Glue quantity

When selecting the amount of glue to dispense, ensure that when setting and pressing down on the crystal, the glue spreads to the edges, thus offering additional protection for the foiling.

Round Stone

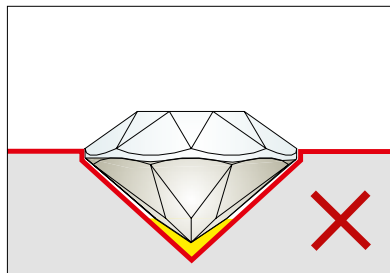
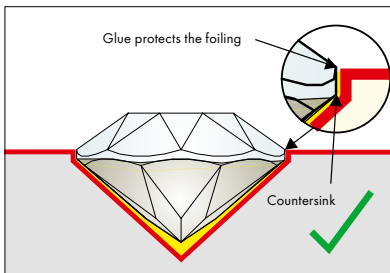

Too little glue

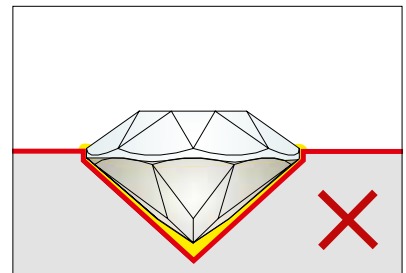

Too much glue

APPLICATION

Fancy Stone

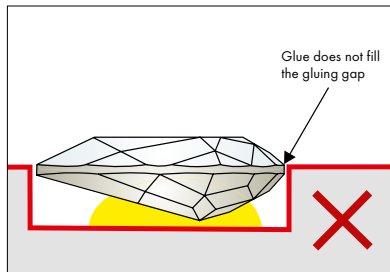
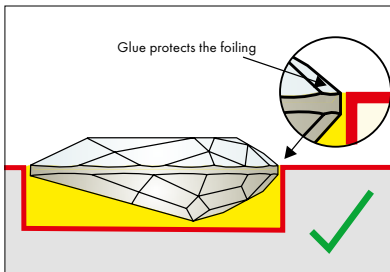

Too little glue

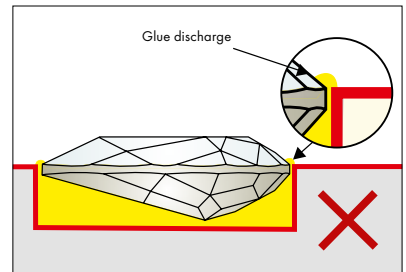

Too much glue

Half Hole Pendant

Two different types of adhesive can be used to affix the single Half Hole Pendant to the metal cap: UV glue and two-component epoxy resin glue.

If using UV glue, the crystal must be permeable to UV light. Please note that some crystal colors absorb UV light and are

thus unsuitable for use with UV glues. Best results in internal tests were achieved using the UV glue DELO-PHOTOBOND GB 368. If the crystal color is not suitable for using UV glue, using epoxy resin glue is suggested. In internal tests, the best bond was achieved using CG 500 (A+B).

For further information about commonly known and globally available glues and their adhesion on metal, please check the overview of glues at the beginning of the chapter "Choice of Glue".

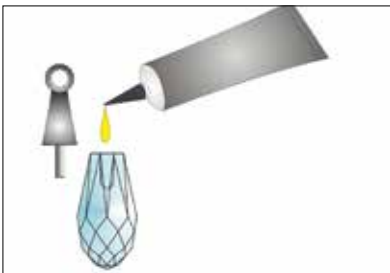

1 To achieve precise and consistent results, it is suggested to use a dosage system. Choose a dispensing tip with a diameter smaller than 1 mm and put a dot of glue into the pendant's hole. The amount of glue used depends on the type of adhesive and its curing behavior; performing application tests is therefore recommended.

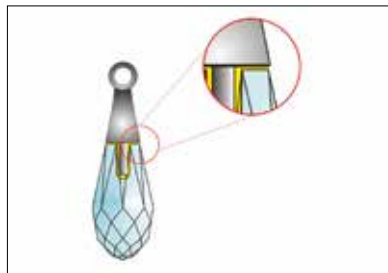

2 After setting the metal cap into the hole, the glue should be evenly distributed in the gluing gap and spread over the edges to also affix the metal part on top of the crystal. Remove excess glue before it is hardening, e.g. with a cotton wipe soaked in isopropyl alcohol.

Crystal Pearl Metal Part

This metal cap can be glued to Crystal Pearls (art. 5810, art. 5818) or Beads (art. 5003, art. 5028) using an adhesive such as the Swarovski crystal glue CG 500 (A+B).

Please follow the whole gluing process (i.e., cleaning, mixing, dosing, setting, curing) carefully. When the glue is dispensed onto the metal part, make sure that the entire

surface of the pin and the base part is covered with the adhesive.

SETTING

Once the glue has been dispensed the Swarovski product can be positioned. Pick up the crystals, for example with a wax stick or tweezers, apply them to the gluing position, and press down gently.

For preparing **Chatons** for the positioning process, a **Chaton Sieve** can be helpful.

Take the black sieve (for size PP 0 - PP 1, art. 9030/003), the gray sieve (for size PP 2 - PP 20, art. 9030/001) or the blue sieve (for size PP 21 - SS 34, art. 9030/002) according to the Chatons' sizes. As the gray and the blue sieves provide two sides with different cavity sizes, make sure to choose the sieve type and side that

perfectly matches the Chatons to be set. Place some crystals onto the sieve. By slightly shaking the tool and wiping over it with glove-covered fingers, the majority of Chatons automatically turn into the suitable position for gluing (table pointing upwards).



Chaton Sieve for Chatons size PP 0 - PP 1 (art. 9030/003)



Chaton Sieve for Chatons size PP 2 - PP 20 (art. 9030/001)



Chaton Sieve for Chatons size PP 21 - SS 34 (art. 9030/002)

As a next step the Chatons can easily be picked up from the Chaton Sieve using a tool like the

wax stick, tweezers, or a vacuum pick-up system. The use of a silicone pick up tool is not recommended

as this can impair the adhesion and the brilliance of the crystals.

Apply the crystals to the gluing position and press down gently. When working with cavities with large gluing gaps, the

following tools assist in ensuring the optimum positioning:



A cross (or a similar tool) prevents the crystal from tipping over. Press the crystal down flat on the material using the chosen tool.

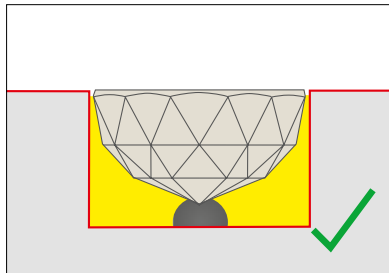

To prevent the crystal from sinking or tipping during the hardening process, a small **plasticine ball** can be used to fix it in place.

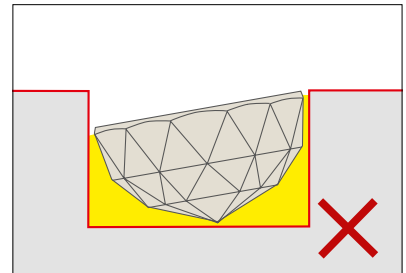

CAVITY PRODUCTION

CHECKING SURFACE
TENSION AND
PRE-TREATMENT

CHOICE OF GLUE

DOSAGE AND SETTING

POST-CLEANING
AND CURING

POST-CLEANING AND CURING

POST-CLEANING

Excess glue that escapes during setting can be carefully removed using a cotton wipe that has been soaked in a solvent,

e.g. isopropyl alcohol. It must be removed **while the glue is hardening**, as dried glue cannot be fully removed. Remember to

follow the glue manufacturer's instructions, as well as considering the resistance of the base material.

CURING

The curing time of the glue depends mainly on the **temperature**, or on the **humidity** in the case of silicone glues. Please note the glue manufacturer's instructions.

To minimize shrinking and tension during

hardening, we recommend a **maximum curing temperature of 50 °C (122 °F)**, with the exception of two-component epoxy resin glues CG 500 (A+B) and CG 610 (A+B).

Both adhesives can be cured at a maximum temperature of **100 °C (212 °F)**, without any changes to its properties.

OVERVIEW OF THE SIMPLIFIED GLUING PROCESS



1 Make sure that the surface on which you want to apply a crystal is suitable for gluing. Use the Test Pen (art. 9030/000) to check the material's surface tension.



2 The surface must be correctly pre-treated before gluing (e.g. cleaning, degreasing).



3 The glue should be applied with a dispenser.



4 Pick up the crystal, using e.g. a tweezers, a plasticine stick or a vacuum pick up system. Carefully place the crystal and press it down gently.



5 Remove excess glue with a cotton stick soaked in a solvent e.g. Isopropyl alcohol. Let the glue cure according to the manufacturer's guidelines.

APPLICATION

CRYSTAL APPLICATION INSTRUCTION MOVIE

Gluing

Watch an example of an gluing process online at <http://swarovski.com/gluing-finished-product>



PRODUCT-SPECIFIC APPLICATION INSTRUCTIONS

APPLYING UV-TRANSPARENT MATERIALS

When using UV glue, **at least one part** of the materials must be translucent for **UV light**. On a metal surface for example, only crystals without foiling can be applied. Similarly, foiled crystals can only be glued

to UV-transparent materials. Please note that some crystal and glass colors as well as UV-stabilized plastics absorb UV light and are thus unsuitable for UV glues.



- 1 The surfaces to be glued must be properly pre-treated to achieve a sufficient surface tension. This can be tested via a Test Pen (art. 9030/000).



- 2 Dispense the UV glue.



- 3 Press down on the crystal, until the glue completely covers the gluing area.

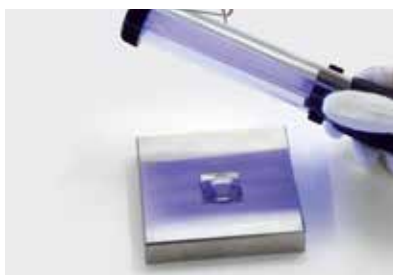

- 4 Cure the glue for a few seconds using a UV light (following the manufacturer's instructions), and remove any excess glue using a cleaning agent. The curing process can then be continued, according to the manufacturer's instructions.

Note: It is recommended that UV-protective eyewear is worn during curing, to prevent injury. Please follow the manufacturer's instructions.

CRYSTAL APPLICATION INSTRUCTION MOVIE

UV gluing with pointed Chatons

Watch UV Gluing instruction movie online at <http://swarovski.com/uv-gluing>



APPLYING SYNTHETICS ON SOLID SURFACES (WITH ADDITIONAL GLUING SYSTEM)



1 The surfaces to be glued must be properly pre-treated, so as to achieve sufficient surface tension.



2 Apply the correct amount of glue onto the carrier material.



3 Elapse the glue equally on the material.



4 Position the motif in the desired location and press down firmly for a few minutes.



5 Glue that escapes during positioning can be carefully removed using a cotton wipe.



6 During curing it is suggested to put some weight on the motif.

APPLYING FLAT BACKS NO HOTFIX FOR MOSAIC TILES

Due to their dimensions (outer dimensions and height) and coating (protective lacquer), selected Flat Backs No Hotfix have been tailored specially for use in tiles and mosaics.

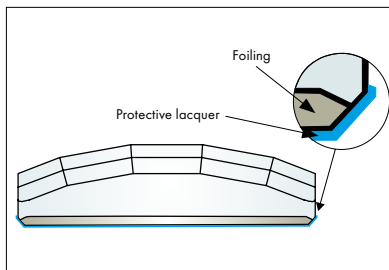

Protective lacquer is applied to the foiling of all crystals, and fully covers the reflective surface. Protective lacquer prevents moisture, cleaning agents, etc. from coming into direct contact with the reflective layer, which can lead to corrosion and damage the crystal.

Long-term, satisfactory solutions can only be achieved with **paper-glued** mosaic tiles and the use of recommended tile glues and joint sealers. When working with **net-glued** mosaics, their absorption and storage of moisture means the **support net** must be **completely removed** in the areas where

the crystals are to be applied.

Find suppliers for tile glues and joint sealers on the supplier list on page 48. Solvent-resistant and alkaline tile glues and joint sealers are not recommended.

Unsuitable areas of application

- In swimming baths and steam rooms
- In contact with chlorine and other aggressive cleaning agents
- In saunas, due to the high temperatures and moisture
- Outside

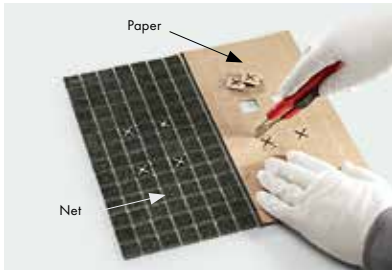

1 Cut out the marked tile area and remove it from the mosaic.



2 Apply the tile glue to the prepared base according to the manufacturer's instructions, then carefully position the mosaic tile and press down.

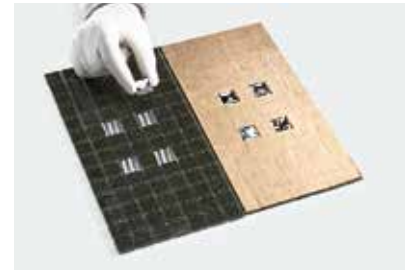

3 Place the individual crystals in the gaps and lightly press down.



4 Before curing, remove any excess glue with a damp sponge; follow the manufacturer's information regarding curing.



5 After curing, remove the paper support. Following this, the mosaic can be grouted with a soft rubber scraper.



6 Excess joint sealer can be removed with a wet sponge during curing.

Note: Please be aware that many tile glues and joint sealers can contain abrasive materials, which can lead to scratching of the crystal. To avoid damaging the crystal, these parts should be carefully cleaned with mild, pH-neutral cleaning agents and cleaning sponges.

USEFUL INFORMATION

APPLICATIONS ON SILVER JEWELRY

Without protection, silver jewelry can turn yellow or black with time due to chemical reactions. To slow or stop these reactions

the surface of silver jewelry is often covered with a temporary (wax-based) or permanent protective coat (varnish-based). Tarnishing

on the surface of the metal often results in a decline in the surface tension under the recommended 38 mN/m.

TARNISHING PREVENTION SYSTEMS

Temporary protection against tarnishing:

- Wax-based
- Low surface tension

Recommendation:

Protect the rest of the piece after gluing

Permanent protection against tarnishing:

- Varnish-based
- Surface tension depends on varnish

Recommendation:

Use a tarnishing protection system with sufficient surface tension

PROTECTIVE FILM

A self-adhesive film can protect against dirt during the application process and aid in positioning.

Blind hole



1 To protect the surface of the material used (e.g. metal, tiles, etc.) from dirt, a self-adhesive film can be applied.



2 It is then cut out along the previously produced cavities.

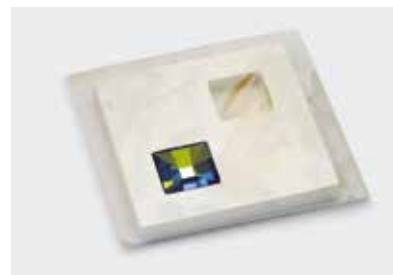

3 The crystal can now be glued into the cavity. Once any excess glue has been removed, the adhesive film can be removed following curing.

End-to-end cavities



1 Apply a self-adhesive film to the front of the material.

2 Place the Flat Backs No Hotfix elements into the end-to-end cavity from the back.

3 Now fill the cavity with glue. The glue should cover the entire foiling of the crystal, so as to avoid corrosion. The self-adhesive film prevents the glue spreading onto the front.

USEFUL INFORMATION



4 Once the glue has cured, the film can be removed.

Note: Highly viscous glues are best suited for end-to-end cavities, as they do not spread through the cracks at the front.

CUTTING AND GLUING CRYSTAL MESH

The transparent film should not be removed before gluing. The film allows the individual crystals to be aligned perfectly, and

provides Crystal Mesh with the stability necessary for flawless application.



- 1 Cut the transparent film between the rows of crystals with a knife, but do not pull them apart, otherwise the stability of the crystals will be lost.



- 2 After cutting the film, there is some space between the crystal rows which allows you further processing.



- 3 Cut the metal mesh with a scissor along the scored line, and remove the excess link rings. The Crystal Mesh is now ready for gluing.

When gluing flexible Crystal Mesh products, do not remove the transparent film until the glue has cured to ensure the proper alignment of the mesh.

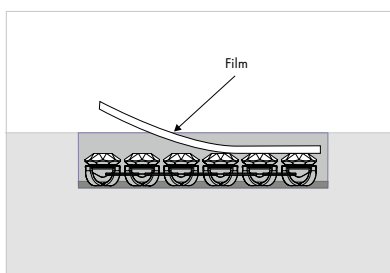

CRYSTAL APPLICATION INSTRUCTION MOVIE

Cutting Crystal Mesh

Learn how to cut Crystal Mesh properly by watching our instruction movie online at <http://swarovski.com/cutting-crystal-mesh>



CUTTING CRYSTALTEX CHATON BANDINGS

When working with Crystaltex Chaton Bandings, the lack of space between crystals means great care must be taken during cutting, so as to avoid damaging the crystal.

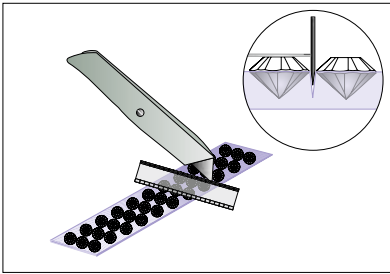

- 1** Cut into the support film between the crystal rows with a Stanley knife.

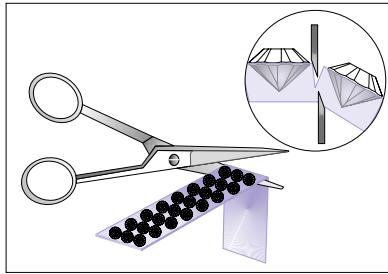

- 2** Snap and cut off the Crystaltex Chaton Banding along the scored edge.

QUICK ASSISTANCE

The following table outlines typical gluing problems, along with possible causes and recommendations on avoiding them.

PROBLEM	CAUSE
The crystal has become discolored:	
The crystal is matt or yellowed.	1, 2
The crystal seems black and dull compared to the surrounding crystals.	3
The crystal has been plated.	4
The crystal has detached from the cavity without the foiling:	
The crystal has become discolored.	5, 6
The crystal has detached with the mirror coating but without the platinum foiling or the glue.	7, 8, 9
The crystal has detached from the cavity with the foiling:	
Glue is attached to the crystal.	10, 11, 12, 13, 14
No glue is attached to the crystal anymore.	15, 16
Excess glue:	
Before hardening.	2
After hardening.	17

CAUSE	RECOMMENDATION
1 Glue residues have not been completely removed and have been smeared over the crystal.	Use a suitable dispenser to apply exactly the right amount of glue. Dispensers with a vacuum connection prevent the glue from dripping and reduce the amount of cleaning needed.
2 Too much glue was used.	Be sure to use the exact recommended dosage and to carefully remove any excess glue, e.g. using acetone or isopropyl alcohol.
3 The axis of the cavity was already off-center in the original model or the cavity was not drilled straight in the unfinished casting.	Use a special bit when drilling the original model. This offers more precise control of the direction and depth of the drilling.
4 The jewelry was only plated after the crystals had been glued to it.	It is recommended to complete the plating before gluing the crystals.
5 A gluing gap that has not been completely filled is causing corrosion.	Make sure the exact dosage of glue is used.
6 Tensile stresses are reducing the adhesion of the mirror coating. Oxygen is penetrating between the stones and the mirroring and causing oxidization.	Use glue that is more elastic and that does not shrink as much.
7 An incorrect glue system was used.	Carry out tests with other glue systems.

CAUSE	RECOMMENDATION
8 Incorrect proportions of resin and hardener were used.	Follow the glue manufacturer's mixing instructions.
9 Cleaning agents have affected the glue and/or the protective coating.	Use less solvent or a different type of solvent.
10 Residues of polishing agent were not completely removed before plating.	Double check the type of cleaning process used.
11 A varnished piece of jewelry has not been correctly pre-treated before gluing.	Improve the adhesion of the glue, e.g. with low-pressure plasma treatment or flame treatment if necessary.
12 Too little glue was used.	Make sure the exact dosage of glue is used.
13 The cavity has the wrong shape after plating.	Re-work the original model to improve the cavity shape.
14 Electrolyte residues have not been completely removed.	Double check the type of cleaning process used.
15 The specified processing time was exceeded and as a result the glue has already hardened.	Reduce the processing time.
16 General glue problems.	Follow the manufacturer's instructions. Check the conditions under which the glue is stored. Excess solvent could have corroded the glue and/or the foiling.
17 The jewelry piece was put under stress before the glue had hardened.	Make sure the glue has hardened, for example before transporting the jewelry.



4

CERALUN

Ceralun is a high-performance, two-component ceramic epoxy composite especially developed for the application of Swarovski products.

- 82** Product Overview
- 83** Machines and Tools
- 85** Suppliers
- 86** Application
- 94** Useful Information
- 95** Quick Assistance

PRODUCT OVERVIEW

The following products are suitable for application with Ceralun:

	CERALUN
Round Stones	✓
Fancy Stones	✓
Crystal Pearls	✓
Flat Backs No Hotfix	✓

Ceralun is a versatile and strong two-component, high-performance ceramic epoxy composite. This clay has been specifically developed and tailored to

embed foiled and unfoiled crystals. It is an absolutely essential material for innovative design. Ceralun has a high level of hardness, rigidity, and shock absorbance.

It is resistant to sweat, humidity, or climatic changes, and shows no aging.

PRODUCT OVERVIEW & MACHINES AND TOOLS

AVAILABLE BASIC COLORS



AVAILABLE SHINING COLORS



MACHINES AND TOOLS

The following machines, tools and aids can be used for the various processes involved in the application of Swarovski products with Ceralun:



Test Pen (art. 9030/000)



Isopropyl alcohol/Acetone



Blow torch



Corona



Plasma cleaner

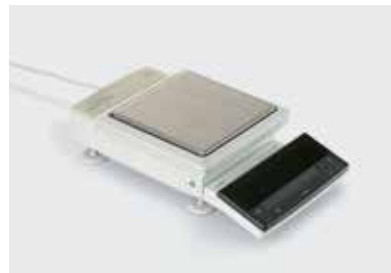

Precision balance



Plastic gloves



Protective eyewear



Ceralun (A + B)

Two-component ceramic epoxy composite
(5 x 20 g)



Ceralun (A + B)
Two-component ceramic epoxy composite
(100 g)



Ceralun (A + B)
Two-component ceramic epoxy composite
(10 x 100 g)



Ceralun (A + B)
Two-component ceramic epoxy composite
(1 kg)



Chaton Sieve for Chatons size PP 0 - PP 1
(art. 9030/003)



Chaton Sieve for Chatons size PP 2 -
PP 20 (art. 9030/001)



Chaton Sieve for Chatons size PP 21 -
SS 34 (art. 9030/002)



Vacuum pump with silicone hose
(art. 9040/022), can be adapted to a
pick-up system by attaching a dispensing tip
(to be ordered separately).



Tweezers



Wax stick



Ceralun Release Agent
Contains high molecular liquid wax (100 ml)



Drying oven



Freezer

SUPPLIERS

This list provides an overview of selected suppliers worldwide.

MACHINES & TOOLS	SUPPLIER	CONTACT
Test Pen	Swarovski: art. 9030/000	www.swarovski-professional.com
Ceralun Basic Colors	Swarovski: art. 9020, 5 x 20 g, Asia, Europe/America art. 9020, 100 g, Asia, Europe/America art. 9020, 10 x 100 g, Asia, Europe/America art. 9020, 1 kg, Asia, Europe/America Black (A+B), Burgundy (A+B), Dark Sapphire (A+B), Indicolite (A+B), Malachite (A+B), Red (A+B), Rose (A+B), Walnut (A+B), White (A+B), Yellow (A+B)	www.swarovski-professional.com
Ceralun Shining Colors	Swarovski: art. 9020, 5 x 20 g, Asia, Europe/America art. 9020, 100 g, Asia, Europe/America art. 9020, 10 x 100 g, Asia, Europe/America art. 9020, 1 kg, Asia, Europe/America Anthracite (A+B), Gold (A+B), Pearl Silk (A+B), Shining Green (A+B), Shining Lilac (A+B), Shining Red (A+B), Silver (A+B)	www.swarovski-professional.com
Ceralun Release Agent	Swarovski: art. 9020 (100 ml)	www.swarovski-professional.com
Vacuum pump with silicone hose, can be adapted to a pick-up system by attaching a dispensing tip	Swarovski: art. 9040/022	www.swarovski-professional.com
Vacuum pick-up system	I & J Fisnar, Inc. Epoxy & Equipment Technology PTE., Ltd. Hottemp (M) Sdn. Bhd. PT. SKT International	www.fisnar.com www.eetdispensing.com www.hottemp.com.my www.sktisolution.com
Chaton Sieve	Swarovski: For Chatons size PP 0 - PP 1: art. 9030/003 For Chatons size PP 2 - PP 20: art. 9030/001 For Chatons size PP 21 - SS 34: art. 9030/002	www.swarovski-professional.com
Pick-up stick	Crystal Ninja, LLC	www.crystalkatana.com
Drying oven	Heraeus Holding GmbH VWR International, LLC	www.heraeus.com www.vwr.com
ELASTOSIL® M 4670 A/B RTV-2 (for preparation of the mold)	Wacker Chemie AG	www.wacker.com

APPLICATION

When working with Ceralun, optimal results are obtained by coordinating the entire application process. Following the application steps in

the right order is very important. Experience has shown that the most common reasons for crystals becoming detached are inappropriate areas of

application, the wrong mixing ratio of the two components, or not mixing them together long enough until a homogenous appearance is achieved.

CERALUN TWO-COMPONENT CERAMIC EPOXY COMPOSITE

Ceralun was especially developed for the application of both foiled and unfoiled Swarovski crystals, exclusively distributed by Swarovski for professional use within the jewelry segment and other industries such as accessories, interiors, and electronics.

Key features

- Specifically developed and tailored to embed foiled and unfoiled Swarovski crystals.
- High level of hardness, rigidity, and shock absorbance.
- Resistant to perspiration, humidity, or climatic changes and shows no aging.

- Allows new design possibilities.
- Perfect material to generate a large variety of surfaces and structures.
- Applicable on 3D-shaped surfaces.
- Alternative solution to gluing.

Technical data of Ceralun

Mixture ratio (A : B), by weight	1 : 1 (resin : hardener)
Pot life at room temperature (23 °C/73.4 °F)	max. 3 h
Complete curing time at room temperature (23 °C/73.4 °F)	72 h
Complete curing time in oven (40 °C/104 °F)	12 h
Complete curing time in oven (80 °C/176 °F)	2 h
Handling time at room temperature (23 °C/73.4 °F)	12 h
Humidity during curing	30 - 70%
Density	2.5 g/cm ³
Hardness (according to DIN 53505)	D82
Storage time at room temperature (23 °C/73.4 °F, 55% rel. hum.)	12 months
Lowest storage temperature	2 °C/35.6 °F

CHECKING SURFACE TENSION AND PRE-TREATMENT

Ceralun has optimal adhesive characteristics for applications on metal, glass, crystal, gluable plastic surfaces, rubber, wood, cork,

and porcelain, unless the materials do not have the right surface tension.

CHECKING THE SURFACE TENSION

The surface tension is an indicator for the wetting properties of the surface the Ceralun should be applied to. A surface tension of at least 38 mN/m is recommended for working

with Ceralun. It should also be randomly tested during production. It is best to use the Test Pen (art. 9030/000) to measure the surface tension.



1 Mark the surface.



2 If the ink remains visible for 2 seconds, the surface is suitable for working with Ceralun.



3 If the ink disappears or forms bubbles, the surface is not suitable for applying Ceralun. In this case, the pre-treatment cleaning methods should be checked.

Note: On porous or absorbent materials, the surface tension cannot be checked with the Test Pen. If the Test Pen is used on highly polluted surfaces (e.g. grease, oil) or on material like wood, the Test Pen might be polluted as well and cannot be used anymore.

CRYSTAL APPLICATION INSTRUCTION MOVIE

Checking surface tension

Watch instruction movie on proper Test Pen usage online at <http://swarovs.ki/gluing-application>



PRE-TREATMENT

If the surface tension is below 38 mN/m, the following pre-treatment cleaning methods,

applied in the correct order, can be effective in reaching the right level.

TYPES OF CLEANING	PRE-TREATMENT CLEANING METHODS
<p>1 Mechanical cleaning</p> <p>This involves sanding, blasting, or brushing but is not usually necessary for jewelry.</p>	<ul style="list-style-type: none"> - Removal of dirt, residues of varnish, rust and/or scale - Roughening the surface
<p>2 Washing and degreasing</p> <p>Here it is important to ascertain that the tensides contain no silicone, as this would impair adhesion.</p> <p>When using solvents it is advisable to test the durability of the surface to be cleaned beforehand to avoid any damage.</p> <p>Solvents containing substances with a high boiling point should not be used due to the high risk of residue. If using cleaning agents, wait a few minutes to allow them to evaporate.</p>	<ul style="list-style-type: none"> - Cleaning with tenside solutions, rinsing with de-ionized water - Cleaning with isopropyl alcohol/ethanol - Cleaning with acetone (MEK/ethyl acetate) - Cleaning with a cleaning solvent: should not contain high boiling point substances (risk of residue)
<p>3 Physical cleaning and activation</p> <p>These cleaning methods can be applied if mechanical cleaning or washing and degreasing are either not possible or have not resulted in a surface tension of >38 mN/m. Therefore the pre-treatment cleaning method used should be done on a case-by-case basis.</p>	<ul style="list-style-type: none"> - Flame treatment with a blow torch The surface to be treated is exposed to the flame of a torch very briefly. When using special gas mixtures, surface silication can also be carried out, so as to apply a more adhesive coating. - Corona treatment An electric corona discharge is briefly applied to the surface. - Plasma treatment Plasma treatment offers precise cleaning and activates the surface via an ionized gas.
<p>4 Chemical cleaning and primers</p> <p>Applying a primer improves adhesion and helps to prevent corrosion.</p>	<ul style="list-style-type: none"> - Applying small amounts of solvent and activating the surface. - Applying a primer.

DOSAGE, MIXTURE AND SETTING

Please pay high attention to not deviate from the recommended mixing ratio of 1:1 of the components (resin and hardener) and to

mix the two components until a homogenous appearance is achieved.

MIXING CERALUN TWO-COMPONENT CERAMIC EPOXY COMPOSITE



1 Cut off resin and hardener with a knife.



2 Weight the two components using an electric scale. The mixing ratio for Ceralun is 1:1 by weight.



3 Both components come in a different shade of color so that it can easily be recognized if they are already properly mixed together.



4 Mix resin and hardener until a homogenous appearance is achieved.

CRYSTAL APPLICATION INSTRUCTION MOVIE

Ceralun

Watch instruction movie online at <http://swarovski.com/ceralun-application>



PROPER SETTING OF CRYSTALS

After mixing the two components together, the crystals can be set. To prepare Chatons for the positioning process, a **Chaton Sieve** can be helpful. Take the black sieve (for size PP 0 - PP 1, art. 9030/003), the gray sieve (for size PP 2 - PP 20, art. 9030/001) or the blue sieve (for size PP 21 - SS 34, art. 9030/002) according to the Chatons' size. Place some Chatons onto the sieve. By slightly shaking the tool and wiping over the crystals with glove-covered fingers, the majority of Chatons automatically get turned into the suitable position for gluing (table pointing upwards).

As a next step the Chatons can easily be picked up from the sieve using a tool like the wax stick, tweezers, or a vacuum pick-up system. The use of a silicone wax stick is not recommended as this can impair the adhesion and the brilliance of the crystals. Apply the Chatons to the desired position and press down gently.

We recommend a maximum working time of three hours at a temperature of 23 °C/73.4 °F to set the Swarovski products. It is not possible to set crystals at room temperature after a period of three hours because the required level of adhesion can no longer be achieved.



Using a Chaton Sieve can facilitate the setting of Chatons

APPLICATION

Please take care that the pavilion of the crystal is surrounded by Ceralun right up to the level of the stone's girdle. It is not necessary to leave any particular space between the crystals when setting them.

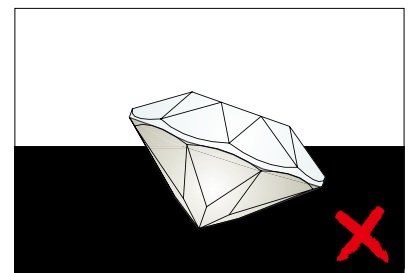
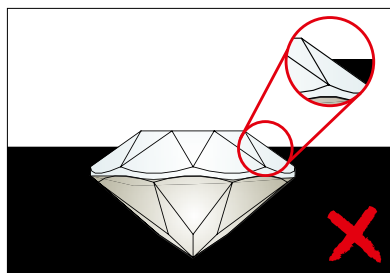
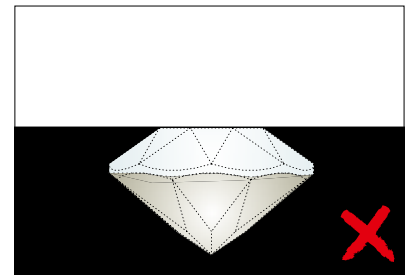
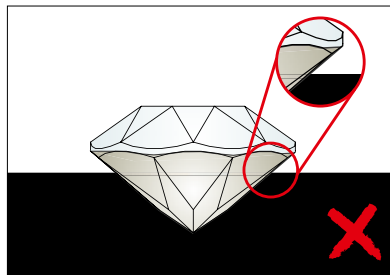
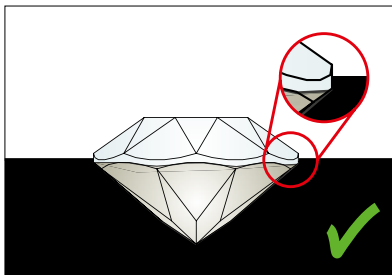

PROCESSING METHODS

DIFFERENT PROCESSING METHODS

Ceralun is the perfect material for generating a variety of surfaces and structures. Possible ways of processing are

the **free forming method**, the **stamping technique** and the **3D silicone molds**.

Free forming



- 1 Place and press the clay onto the relevant area. Be careful not to trap air between Ceralun and the base material.



- 2 Mold the surface into the required shape.



- 3 Smooth the surface of the Ceralun with the recommended Release Agent (art. 9020)



- 4 Pick up the crystal with a vacuum pick-up system - or with a pair of tweezers or a wax stick. Carefully place the crystal and press it down gently.

Generating shiny surfaces with the free forming method

When a piece of jewelry is created where parts of Ceralun are visible, a smooth and shiny clay surface might be desired. In order to create a shiny surface,

gently wipe and polish the clay with your silicone glove-covered finger using the recommended Release Agent or some water drops. The Ceralun surface can be

polished up to 2 hours after the crystals have been set.

Stamping technique

The stamping technique is suitable to produce structured surfaces.



1 Pre-treat the pattern cautiously with the recommended Release Agent.



2 Gently press the pattern onto the surface.

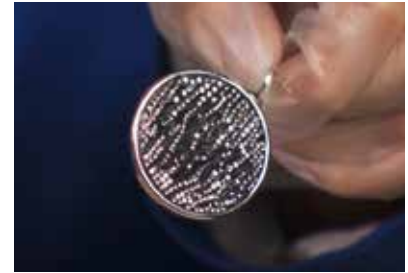

3 After removing the pattern from the clay, the crystals can be set.

Generating shiny surfaces with the stamping technique

If a larger surface of shiny Ceralun is needed, the following tools are required: transfer foil, a pasta machine or rolling pin, and a freezer. Knead the clay and put it between two layers of foil. Smoothen it

with the help of a pasta machine or with a rolling pin. Using the pasta machine is the recommended option, as a consistent height of the Ceralun is achieved easier than with the rolling pin. When the clay inside the foil

is as flat as desired, put it into the freezer for approx. 15 minutes. The cold reduces the bonding between Ceralun and foil, so that the foil can easily be detached from the flat and shiny clay.

CHECKING SURFACE TENSION
AND PRE-TREATMENTDOSAGE, MIXTURE AND
SETTING

PROCESSING METHODS

CURING

3D silicone molds

The work and cost saving method of using 3D silicone molds is recommended for larger production units.

A 3D silicone mold is produced based on a master model. This can be re-used for several times.



- 1 First press the Ceralun into the 3D silicone mold to form the required shape.



- 2 Any overlapping material can be trimmed off with a knife.

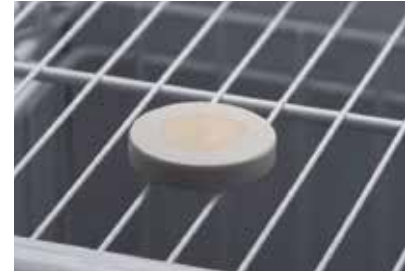

- 3 In order to make it easier for you to remove the Ceralun from the mold, it should first be stored in the freezer. The length of time the filled mold should remain in the freezer depends on the thickness and amount of the Ceralun used.



- 4 After taking the mold out of the freezer, the Ceralun can be removed from it and gently pressed into place on the chosen object.



- 5 Please be sure to remove any condensed water.



- 6 Once the Ceralun reaches a lukewarm temperature, you can proceed with setting the crystals.

CHECKING SURFACE TENSION
AND PRE-TREATMENTDOSAGE, MIXTURE AND
SETTING

PROCESSING METHODS

CURING

CURING

The hardening time and final adhesion strength of Ceralun are dependent on the temperature. The total hardening time at

room temperature of 23 °C (73.4 °F) takes 72 hours. This can be accelerated using heat of max. 80 °C (176 °F).

USEFUL INFORMATION

EXTENSION OF POT LIFE



- 1** Store already mixed Ceralun in a freezer to extend the pot life. Ceralun can be stored in a freezer for up to 24 hours at a temperature of around - 20 °C (- 4 °F).
- 2** This makes it possible to interrupt the setting process and continue again later without losing the adhesion force.
- 3** It is necessary to gently remove any condensed water that occurs during the defrosting process.

USEFUL INFORMATION & QUICK ASSISTANCE

MIXING DIFFERENT COLORS OF CERALUN

You can mix different colors together as you wish. Please consider that you have to

separately mix the epoxy resin and hardener of each color before you mix them together.

Below you find some examples of mixed colors and the corresponding mixing ratio.

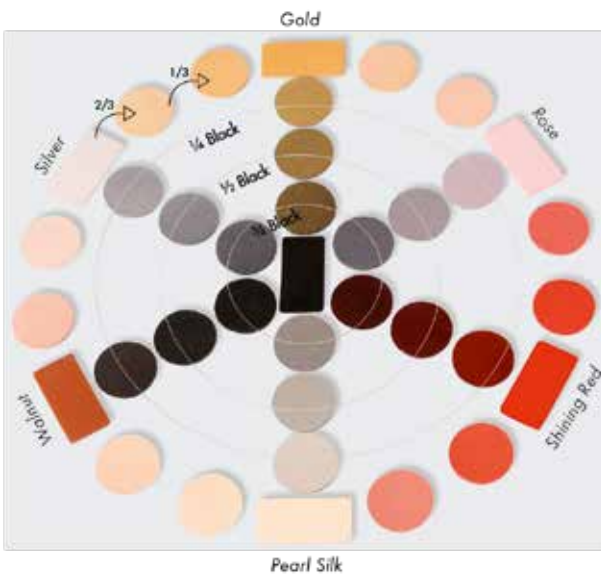

Based on Black

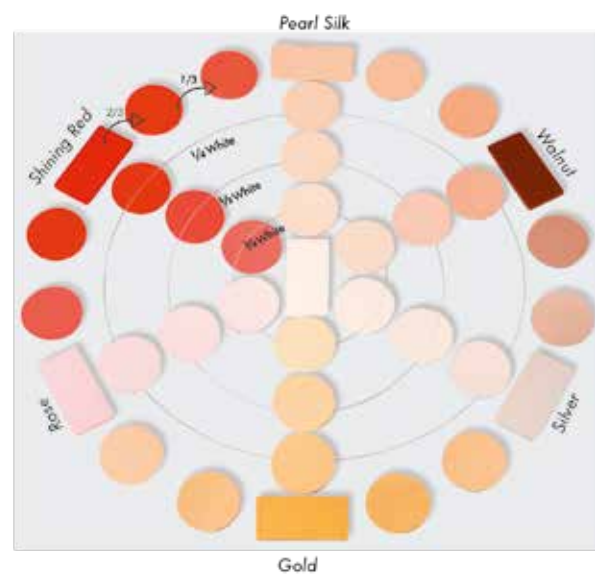

Based on White

QUICK ASSISTANCE

The following table outlines typical Ceralun application problems, along with possible causes and recommendations on avoiding them.

PROBLEM	CAUSE
Ceralun does not cure.	1, 2, 6
Ceralun is not bonding with the base material.	1, 2, 3, 6
Crystals fall off.	1, 2, 4, 5, 6
Ceralun cannot be removed from the silicone mold.	7, 8
Using the stamping technique, Ceralun cannot be removed from the surface pattern.	7
Ceralun appears foggy/cloudy after curing.	5, 6, 7

CAUSE	RECOMMENDATION
1 An error has occurred during the calculation of the right mixing ratio between the two components (resin/hardener).	Do not deviate from the recommended mixing ratio of the components (resin/hardener), 1 : 1.
2 Resin and hardener have not been mixed until a homogenous appearance was achieved.	Be sure to use the exact recommended dosage and mix both components until a homogenous mixture is achieved.
3 The base material is not suitable for using Ceralun or it has been incorrectly pre-cleaned.	Check the surface tension. If the surface tension is below 38 mN/m, carry out pre-treatment cleaning methods.
4 The specified processing time was exceeded and as a result Ceralun has already hardened.	Reduce the processing time to a maximum of two hours at a temperature of 23 °C (73.4 °F).
5 If stored in the freezer, condensed water can occur during the defrosting process.	Take care to gently remove any condensed water that occurs during the defrosting process.
6 Ceralun has been stored for too much time in the freezer.	Make sure not to exceed the recommended time of 24 hours when Ceralun is stored in a freezer at a temperature of around - 20 °C (- 4 °F).
7 No or not enough Release Agent has been used.	The Release Agent is a useful tool to be able to remove Ceralun from any surface. Carefully dose the used amount of Release Agent.
8 Ceralun has not been stored in a freezer or has been stored for too little time.	Storing Ceralun in a freezer makes it easier for you to remove it from the mold.



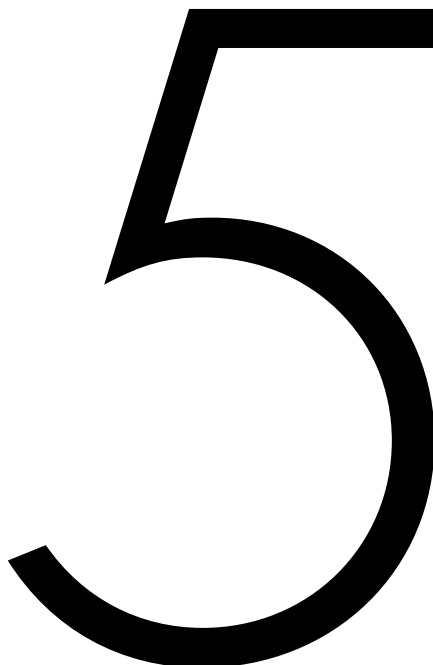

SELF-ADHESIVE ELEMENTS

Self-adhesive Elements are eye-catching and innovative products that come ready-to-apply. Their glue-covered reverse side allows easy and fast application.

When applied on paper and solid surfaces, they can create fantastic designs. Coldfix is a perfect alternative for leather and textiles which are not suitable for Hotfix application.

- 98** Product Overview and field of usage
- 100** Machines and Tools
- 101** Suppliers
- 102** Application
- 115** Quick Assistance

PRODUCT OVERVIEW AND FIELD OF USAGE

The following products are suitable for listed carrier materials:

	APPLICATION ON SOLID MATERIALS*	APPLICATION ON TEXTILE MATERIALS AND LEATHER**
Crystal-it Infinity	✓	
Crystal Fabric-it	✓	
Crystaltex-it	✓	
Crystaltex Chaton-it	✓	
Crystal Rocks-it	✓	
Crystal Fine Rocks-it	✓	
Crystal Ultrafine Rocks-it	✓	
Crystal Fabric Coldfix		✓
Crystal Fine Rocks Coldfix		✓

* application on solid materials such as e.g. paper, metal, glass. The material needs to be suitable for gluing.

** application on textile materials and leather which are not suitable for Hotfix application.

Self-adhesive Elements have a coating of a pressure-sensitive glue on the back, enabling swift, simple application. This glue is activated by **pressure** (applied either by hand, rubber roller or heat press), and bonds with the carrier material.

Crystal -it Infinity and Synthetic-it motifs are suitable for the application on solid materials, while Coldfix is suitable for application on textile materials and leather which are not suitable for Hotfix application.

As **Synthetics** are available as **Hotfix**, **IT** and **Coldfix** version, please find here for a detailed overview the different material composition and proper fields of application

for each product group. In general, all 3 versions are build-up very similar. The main difference will be in the adhesive used at the reverse side of the product.

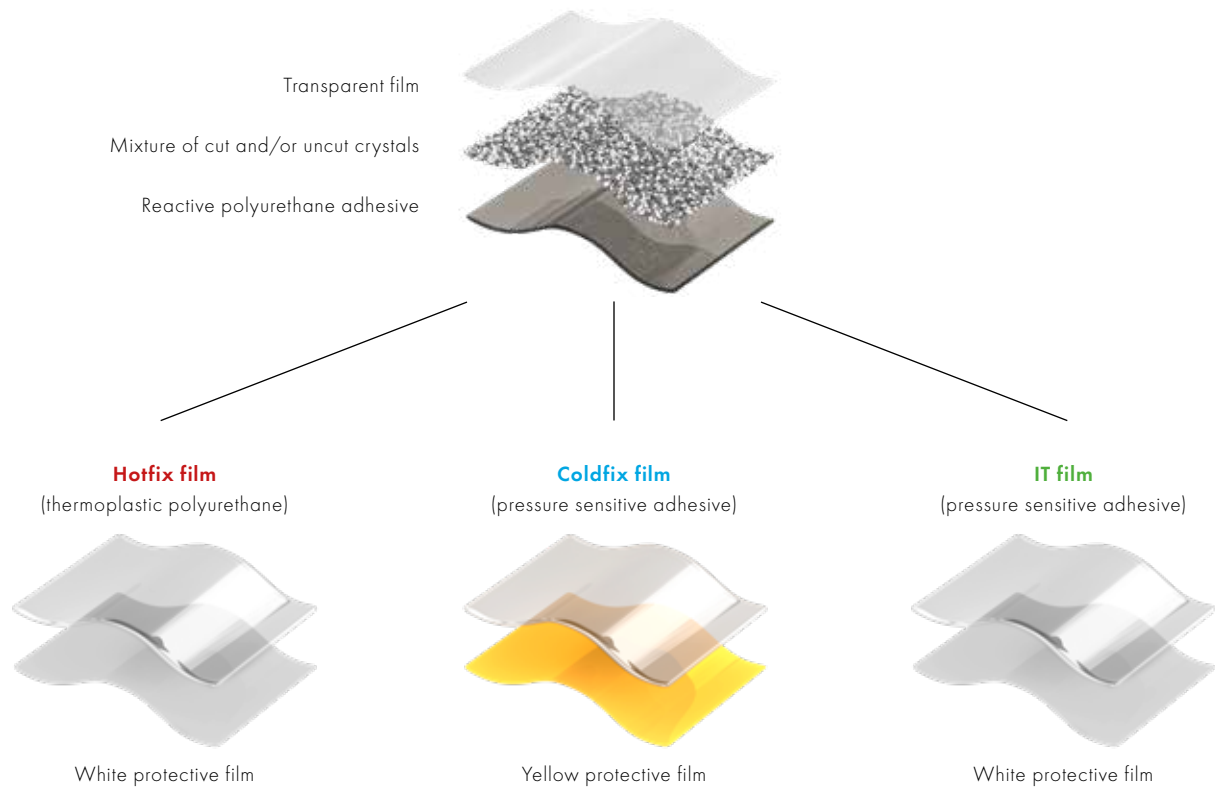

- Heat resistance (min. 120 °C / 285 °F)
- Resistance against pressure
- Application area of the product
- Suitability of surface properties and absorbency

- Heat-sensitive carrier materials (e.g. silk, cashmere, real and artificial leather ...)
- Pressure-sensitive carrier materials (e.g. wool, real and artificial leather ...)
- Textiles with a low level of absorbency (e.g. functional fabrics with water-repellent coating, ...)
- Easy and fast embellishment of finished products

- Solid materials which are suitable for gluing (surface tension of at least 38mN/m)

Please keep in mind: Coldfix is not a replacement for our Hotfix products - it is a new alternative for difficult carrier materials that are incompatible with Hotfix products.

If Hotfix is applicable, we recommend using Hotfix technique as the achievable bonding strength is higher than applying a Coldfix product.

MACHINES AND TOOLS

The following machines, tools and aids can be used for applying Self-adhesive Elements.

Especially for Coldfix application onto textiles and leather:



Rubber roller



Heat press

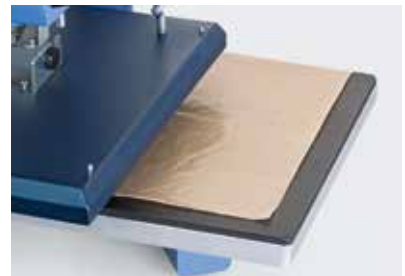

Teflon® foil (art. 9010/003)

Especially for IT- application onto solid materials:



Test Pen (art. 9030/000)



Blow torch



Isopropyl alcohol/Acetone



Plasma cleaner



Corona



Plastic Gloves



CNC milling machine

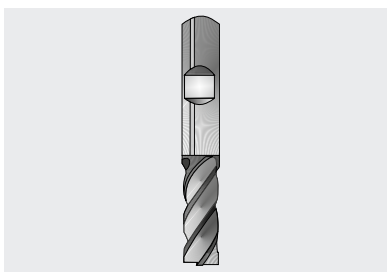

Milling cutter



Protective eyewear

SUPPLIERS

This list provides an overview of selected suppliers worldwide.

MACHINES & TOOLS	SUPPLIER	CONTACT
NC drill/milling cutter	Dixi Holding SA Hahn & Kolb GmbH Hoffmann GmbH Reich Präzisionswerkzeuge Wedco	www.dixi.ch www.hahn-kolb.de www.hoffmann-group.com www.reich.at www.wedco.at
Test Pen	Swarovski: art. 9030/000	www.swarovski-professional.com
Heat press	Bestblanks Elna SMP Singapore Fukutomi Technologies Hix Corporation Zhejiang Huangyan Garment Machinery Factory Jesse J. Heap & Son, Inc. Nagel & Hermann OSHIMAKK Co., Ltd. Pro World ColDesi, Inc RPL Supplies, Inc. STAHL'S Europe GmbH Teva Thermopress Europe	www.bestblanks.com www.elnasingapore.com www.sublihub.com www.hixcorp.com www.ji-feng.com www.jesseheap.com www.strass.cc www.oshima.com.tw www.proworldinc.com www.rhinestonecamsmachines.com www.rplsupplies.com www.stahls.de www.teva-organisation.com www.thermopress.de
Double heat press	Teva Wagner GmbH	www.teva-organisation.com www.wagner-transferpressen.de
Teflon® foil (100 x 50 cm, 40 x 20 in)	Swarovski: art. 9010/003	www.swarovski-professional.com
Rubber roller	Regiotape GmbH AJC Tools & Equipment Co.	www.regio-tape.de www.ajctools.com

APPLICATION

When applying Swarovski Self-adhesive Elements, optimal results are obtained by coordinating the entire application process. Follow the application steps in the right order is very important. Experience has shown that the most common reasons

for Crystal-it Infinity, Synthetic-it and Coldfix products becoming detached are inappropriate areas of application, not suitable carrier materials, and wrong application process (e.g. wrong angle when removing film, too less pressure during application).

Before beginning the application process, you should always check whether the carrier material is suitable for application of Self-adhesive Elements.

CAVITY PRODUCTION

The cavity makes it easy to position Crystal Fabric-it, Crystaltex-it, Crystaltex Chaton-it, Crystal Rocks-it, Crystal Fine Rocks-it and Crystal Ultrafine Rocks-it exactly and

ensures higher protection of the crystal product against mechanical and chemical stress. There are several different production methods and cavity types.

PRODUCTION METHODS

– **Milling** is when materials are machined using a milling machine and milling cutter. Milling machines can be fitted with appropriate tools depending on the materials, e.g. for working with

metal and plastic, wood, or natural stone. Modern CNC machining centers offer the greatest precision and can be used to produce **cavities of every shape** necessary. Please note

that when machining natural stone, ceramic, or glass, for example, special diamond-tipped tools must be used.

APPLICATION

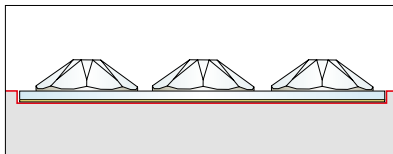
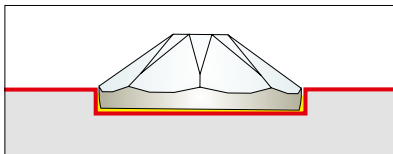
SWAROVSKI PRODUCTS	PRODUCTION METHOD	CAVITY TYPE
Crystal Fabric-it Crystaltex-it Crystaltex Chaton-it Crystal Rocks-it Crystal Fine Rocks-it Crystal Ultrafine Rocks-it	Milling Casting	<p>Indentation</p>  
<p>When gluing an article with a flat back it is also advisable to create a cavity as shown here. This cavity ensures that the crystal is better protected against mechanical and chemical stress. The depth of the cavity depends on the height of the girdle and the thickness of the base material.</p>		

PRODUCTION TOLERANCES FOR CAVITIES

Note: When producing cavities, the dimensions should consider the tolerance of the product and the production

tolerance. The tolerances of the product can be requested from your Swarovski representative.

CHECKING SURFACE TENSION AND PRE-TREATMENT

Before beginning the application process, you should always check whether the carrier material is suitable for application of Self-adhesive Elements.

There are different material checks necessary, depending if you want to apply a **Crystal-it Infinity** or **Synthetic-it on a solid material** or a **Coldfix product onto a textile or leather carrier material**.

Nevertheless, please note that there are certain types of plastics used for **solid materials, textile and leather treatments** that are difficult for any gluing connection.

The following table contains a selection of materials that can cause problems for any glue application:

Plastic	Examples	Adhesive Qualities
Polyamide (PA)	Degamid, Nylon, Perlon	very difficult
Polyethylene (PE)	Geberit, Hostalen G, Ferrozell	difficult
Polyethylene Terephthalate (PET)	Cardura, Atlas, Eralyt	difficult
Polyoxymethylene (POM)	Delrin, Kematal, Ertacetal	difficult
Polypropylene (PP)	Moplefan, Proplex, Verelite	difficult
Polytetrafluoroethylene (PTFE)	Teflon®, Gaflon, Ferrotron	very difficult
SILICONE	Silopren, Contiduct, Corotex	very difficult

MATERIAL CHECK AND PRETREATMENT FOR SOLID MATERIALS WHEN USING IT PRODUCTS

Checking the surface tension

The surface tension is an indicator for the wetting properties of the surface to be glued. A surface tension of **at least 38 mN/m** is recommended for gluing

Swarovski crystals. It should also be randomly tested during production. It is best to use the Test Pen (art. 9030/000) to measure the surface tension.



1 Before gluing, mark the surface.



2 If the ink remains visible for 2 seconds, the surface is suitable for gluing.



3 If the ink disappears or forms bubbles, the surface is not suitable for gluing. In this case, the pre-treatment cleaning methods should be checked.

Note: On porous or absorbent materials, the surface tension cannot be checked with the Test Pen. If the Test Pen is used on highly polluted surfaces (e.g. grease, oil) or on material like wood, the Test Pen might be polluted as well and cannot be used anymore.

CRYSTAL APPLICATION INSTRUCTION MOVIE

Checking surface tension

Watch instruction movie on proper Test Pen usage online at <http://swarovski.com/gluing-application>



Pre-treatment

If the surface tension is below 38 mN/m, the following pre-treatment cleaning methods, applied in the correct order,

can be effective in reaching the right level. After each cleaning process, the surface tension has to be checked again.

TYPES OF CLEANING	PRE-TREATMENT CLEANING METHODS
<p>1 Mechanical cleaning This involves sanding, blasting, or brushing but is usually not necessary for jewelry.</p>	<ul style="list-style-type: none"> - Removal of dirt, rust, scale, and residues of varnish - Roughening the surface
<p>2 Washing and degreasing It is important to ascertain that the tensides do not contain silicone, as this would impair adhesion. When using solvents it is advisable to test the durability of the surface to be cleaned beforehand to avoid any damage. Solvents containing substances with a high boiling point should not be used due to the risk of residue. If using cleaning solvents, wait a few minutes to allow them to evaporate.</p>	<ul style="list-style-type: none"> - Cleaning with tenside solutions, rinsing with de-ionized water - Cleaning with isopropyl alcohol/ethanol - Cleaning with acetone (MEK/ethyl acetate) - Cleaning with a cleaning solvent: should not contain high boiling point substances (risk of residue)
<p>3 Physical cleaning and activation These cleaning methods can be applied if mechanical cleaning or washing and degreasing are either not possible or have not resulted in a surface tension of >38 mN/m. Therefore the pre-treatment cleaning method used should be done on a case-by-case basis.</p>	<ul style="list-style-type: none"> - Flame treatment via a blow torch The surface to be treated is exposed to the flame of a torch very briefly. When using special gas mixtures, surface silication can also be carried out, so as to apply a more adhesive coating. - Corona treatment An electric corona discharge is briefly applied to the surface. - Plasma treatment Plasma treatment offers precise cleaning and activates the surface via an ionized gas.
<p>4 Chemical cleaning and primers Applying a primer improves adhesion and helps to prevent corrosion.</p>	<ul style="list-style-type: none"> - Applying small amounts of solvent and activating the surface. - Applying a primer.

MATERIAL CHECK FOR TEXTILES AND LEATHER WHEN USING COLDFIX

When applying Coldfix **using a heat press with a temperature of 90 °C (195 °F)** increases the bonding strength of the product and reduces the time of achieving the final strength, please check the following criteria:

- Heat resistance (min. 90 °C / 195 °F)
- Resistance against pressure
- Application area of the product (no bended/shaped area of the design)

Coldfix was developed for application on leather and textiles, which are not suitable for the Hotfix application process.

Note: To ensure the best possible result, test applications on the intended carrier material are strongly recommended.

PREPARATION

Prior to application, some Swarovski products need some special preparation to achieve a high-quality gluing connection.

PREPARATION WHEN APPLYING SYNTHETIC-IT

Cutting Crystaltex Chaton Bandings

When working with Crystaltex Chaton Bandings, the lack of space between crystals means great care must be taken during cutting, so as to avoid damaging the crystal.

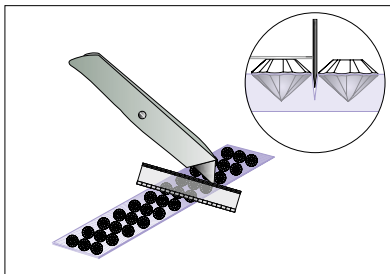

1 Cut into the support film between the crystal rows with a Stanley knife.

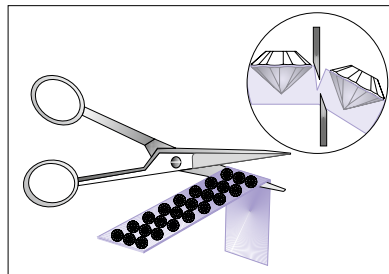

2 Snap and cut off the Crystaltex Chaton Banding along the scored edge.

PREPARATION WHEN APPLYING COLDFIX-MOTIFS

Coldfix motifs are delivered on a sheet. Depending on the sizes and the shape of the motif, the quantity of motifs on a sheet can vary. Before separating the single

motifs, it's recommended to press the motifs using your hand or a rubber roller onto the transparent foil. Use a scissor to cut between the motifs.

Now the motifs are ready for further processing and application.

CAVITY PRODUCTION

CHECKING SURFACE TENSION
AND PRE-TREATMENT

PREPARATION

APPLICATION

APPLICATION

APPLYING CRYSTAL-IT INFINITY

This self-adhesive product consists of Flat Backs in different shapes, sizes, heights, and colors. If applying it on materials such as metal, make sure the surface is free of pollution such as grease or oil.



1 Before starting, put the motif onto a solid underlay such as a desk and press the crystals onto the transparent film. This can easily be achieved when the transparent film points upwards.



2 Make sure the motif still lays on the desk, this time with the white protective film pointing upwards. Fix the motif with one hand, while peeling off the white film at an acute angle with the other hand.



3 Position the motif in the location desired and press down firmly.



4 Carefully remove the transparent film at an acute angle and press down the motif again.

Note: the minimum application temperature is 18 °C (64 °F) with the glue fully hardening after 72 hours.

CRYSTAL APPLICATION INSTRUCTION MOVIE

Crystal-it Infinity

Watch instruction movie on how to apply Crystal-it Infinity online at <http://swarovs.ki/crystal-it-infinity>



APPLYING SYNTHETIC-IT

Synthetic-it products can be applied in two different ways: Dry application or Wet application

Dry application



1 The surfaces to be glued must be properly pre-treated, so as to achieve sufficient surface tension.



2 Press the motif onto the transparent film.



3 Peel off the white protective film at an acute angle.



4 Position the motif in the location desired and press down firmly for around 10 seconds.



5 Carefully remove the transparent film at an acute angle and press down on the motif again.

Note: Prevent the self-adhesive back from sticking together, as separating it can cause damage. The minimum application temperature is 18 °C (64 °F), with the glue fully hardening after 72 hours.

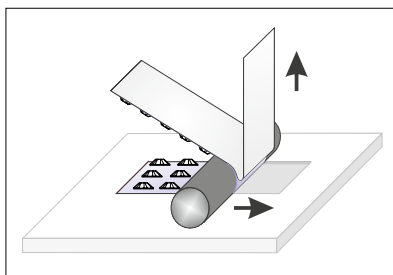

When applying Synthetics-it remove the white protective film during application in the pre-produced cavity.

Wet application

For larger motifs and those that must be positioned accurately on surfaces, a wet application is recommended. It is essential,

however, that the base does not absorb the soap water that is used here.



- 1 Moisten the cleaned surface with soap water.



- 2 Carefully peel off the white protective film at an acute angle, and carefully position the product on the wet surface. After positioning it, press down on the soap water beneath the motif, e.g. using a rubber roller.



- 3 Carefully remove the transparent film at an acute angle and leave the surface to dry.



- 4 After drying, press down firmly on the motif again, e.g. using a rubber roller.

Note: Prevent the self-adhesive back from sticking together, as separating it can cause damage. The minimum application temperature is 18 °C (64 °F), with the glue fully hardening after 72 hours.

APPLYING COLDFIX

There are two ways of applying Coldfix products depending on material and application field.

Cold application (room temperature)

- Coldfix product is placed on a suitable carrier material and pressed down using a rubber roller. Final adhesive strength is reached after 72 hours.

Application using a heat press

(90 °C/195 °F) - Coldfix is applied from the reverse side using a heat press. Final adhesive strength is reached after 12 hours.

Please be aware that when applying Coldfix products using a heat press at some materials adhesion strength can be increased.

At subsequent table some examples of adhesive strength differences are shown:

APPLICATION

CARRIER MATERIAL DESCRIPTION	ACHIEVABLE PEEL ADHESION*	
	Cold application (room temperature) Final adhesive strength reached after 72h	Application using a heat press (90 °C/195 °F) Final adhesive strength reached after 12h
Tamurakoma N2012 col23 40g/m ²	3-4 N/cm	3-4 N/cm
Gabardine TC black 210g/m ² , 65% polyester, 35% cotton	3-4 N/cm	6-7 N/cm
lycra GGAQ black 120g/m ² , 73% polyamide, 27% elastane	8-9 N/cm	9-10 N/cm
Alcantara® regular 5015 black 230 g/m ² , 68% polyester, 32% polyurethane	3-4 N/cm	8-9 N/cm
Grain leather, black	5-6 N/cm	6-7 N/cm
Artificial leather black, 100% polyurethane, 315 g/m ²	4-5 N/cm	4-5 N/cm

* Tested following DIN 1939

Please note that achievable peel adhesion and bonding performance depend entirely on the characteristics of the carrier material used; it should be remembered that a gluing connection is only as good as the carrier material surface allows. Any oral, written, or test-based advice that Swarovski provides

regarding techniques for the application of its products are recommendations based on Swarovski's current knowledge and the information provided by its suppliers. **Such advice does not discharge customers from carrying out their own tests on techniques they propose to use, and**

the suitability of these techniques for the intended application. The application, use and processing of these techniques and products are solely the user's responsibility.

CAVITY PRODUCTION

CHECKING SURFACE TENSION
AND PRE-TREATMENT

PREPARATION

APPLICATION

Cold application (room temperature)

1 Before application, press the motif onto the transparent film.



2 Peel off the yellow protective film at an acute angle.



3 Place the motif on the carrier material and press down firmly for around 10 seconds with a rubber roller.



4 Carefully remove the transparent film at an acute angle.



5 After removing the transparent film press down a last time firmly on the motif using a rubber roller. The application is now finished.

Note: Final adhesive strength is reached after 72 hours.

CRYSTAL APPLICATION INSTRUCTION MOVIE**Cold application**

Watch instruction movie on how to apply Coldfix at room temperature online at <http://swarovski.com/coldfix-cold-temp>



Application using a heat press (90 °C/195 °F)

APPLICATION



1 Before application, press the motif onto the transparent film.



2 Peel off the yellow protective film at an acute angle.



3 Position the motif in the location desired.



4 Place the carrier material with the motifs facing down in a heat press.



5 Use a Teflon® foil to protect the heat press.



6 Close the heat press and apply the motif with 5 seconds, 90 °C (195 °F) and medium pressure!*



7 After the application is finished use a pressing cloth or a rubber roller to apply additional pressure to the product.



8 Once the product is at least hand warm the transparent film can be removed at an acute angle. The application is now finished.

Note: Final adhesive strength is reached after 12 hours

* The application time depends primarily on the thickness of the carrier material used and should be tested by the customer.

CRYSTAL APPLICATION INSTRUCTION MOVIE

Coldfix: application using a heat press

Watch instruction movie on how to apply Coldfix using a heat press online at <http://swarovski.com/coldfix-low-temp>



ADDITIONAL APPLICATION ADVICE

It is possible to move or use the final product carefully right after the application, as long as it is not exposed to any mechanical or chemical stress until the final adhesive

strength is achieved. The time until the final adhesive strength is achieved varies depending on the application method (72 or 12 hours). Please note, that any washing

or quality assurance should take place after this period.

COLDFIX CARE INSTRUCTIONS



Turn inside out and use mild laundry detergent (wash by hand, max. temp. 30 °C, very mild process).



Do not use chlorine bleach!



Do not tumble dry!



Do not iron!



The textile will withstand gentle professional wet cleaning. Turn inside out.

To protect the crystals as much as possible, the use of a soft wash bag is recommended.

QUICK ASSISTANCE

The following table outlines typical gluing problems, along with possible causes and recommendations on avoiding them.

PROBLEM	CAUSE
The motive has insufficient adhesive power to the base material.	1, 2, 3, 4
The fabric or leather has changed its appearance after using the heat press (when applying Coldfix motif using a heat press).	5, 6, 7
The transparent film leaves pressure marks on delicate carrier materials.	5, 6, 7, 8
Loose Flat Backs remain on the white protective film (Crystal-it Infinity).	9
Loose Flat Backs remain on the transparent film (Crystal-it Infinity).	10
The separation of the white protective film and the transparent film is difficult.	11

CAUSE	RECOMMENDATION
1 Cleaning agents have affected the glue.	Use less solvent or a different type of solvent.
2 The base material was put under stress before the glue had reached its final strength.	Make sure that the suggested waiting time was respected (depends on product type and application process).
3 The pressure is too low.	Thick fabrics and certain products need higher pressure.
4 The surface of the base material is not clean.	Clean the base material.
5 The pressure is too high.	Reduce the pressure of the heat press.
6 The application time is too long.	Reduce the application time.
7 The ironing pad is too hard.	Use a soft silicone pad.
8 The transparent film leaves pressure marks.	Cut away more of the film, closer to the edge of the motif, to reduce marking.
9 The Flat Backs do not stick on the transparent film.	Press the crystals to the transparent support film before removing the protective foil.
10 The crystals do not stick on the base material after application.	Press the crystals to the base material before removing the transparent film.
11 The white film sticks very strong together with the transparent film.	Cut away more of the film, closer to the edge of the motif.

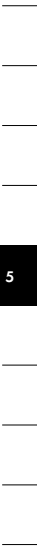





HOTFIX APPLICATION

The Swarovski product assortment includes a wide range of Hotfix products. These can be applied simply, quickly and securely. Hotfix technology is ideal for application in the fields of textiles, interior décor and accessories.

118	Product Overview
118	Machines and Tools
120	Suppliers
121	Application
132	Useful Information
137	Quick Assistance
138	Swarovski Hotfix Selector

PRODUCT OVERVIEW

The following products are suitable for Hotfix application:

	HOTFIX APPLICATION
Flat Backs Hotfix	✓
Transfers	✓
Synthetics Hotfix	✓
Crystal Mesh	✓

MACHINES AND TOOLS

The following machines, tools and aids are used in the Hotfix application of Swarovski crystals:



Heat press



Double heat press



Continuous fusing press



Ultrasonic device



Stone setting machine

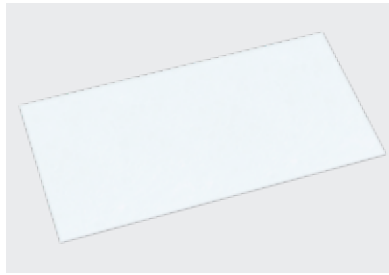
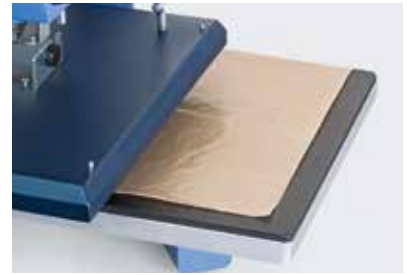
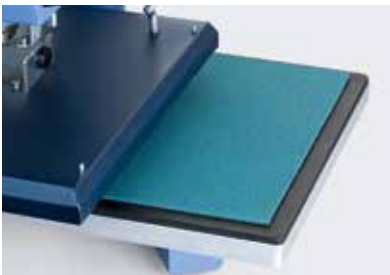
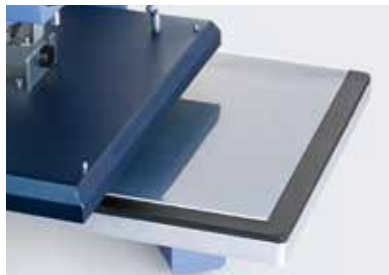
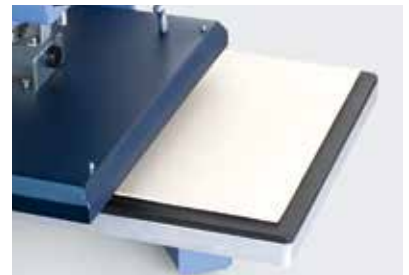
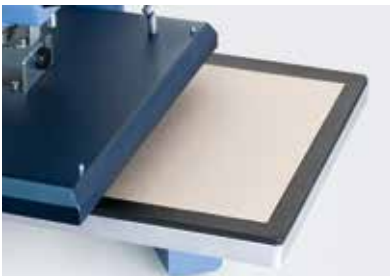
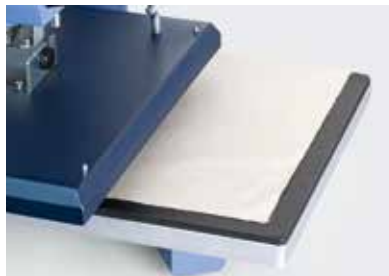

Applicator

**Iron****Silicone board** (tool for designing Transfers) (art. 9010/006)**Teflon® foil** (art. 9010/003)**Silicone ironing pad** (foam) (art. 9010/002)**Silicone pad** (tool for Crystal Diamond Transfers) (art. 9010/005)**Felt****Standard cardboard****Standard pressing cloth****Temperature measuring strips** (art. 9010/007)**Laser temperature measuring device****Transfer film**

SUPPLIERS

This list provides an overview of selected suppliers worldwide.

MACHINES & TOOLS	SUPPLIER	CONTACT
Heat press	Bestblanks	www.bestblanks.com
	Elna SMP Singapore	www.elnasingapore.com
	Fukutomi Technologies	www.sublihub.com
	Hix Corporation	www.hixcorp.com
	Zhejiang Huangyan Garment Machinery Factory	www.ji-feng.com
	Jesse J. Heap & Son, Inc.	www.jesseheap.com
	Nagel & Hermann	www.strass.cc
	OSHIMAKK Co., Ltd.	www.oshima.com.tw
	Pro World	www.proworldinc.com
	ColDesi, Inc	www.rhinestonecamsmachines.com
	RPL Supplies, Inc.	www.rplsupplies.com
	STAHL'S Europe GmbH	www.stahls.de
	Teva	www.teva-organisation.com
Thermopress Europe	www.thermopress.de	
Double heat press	Teva	www.teva-organisation.com
	Wagner GmbH	www.wagner-transferpressen.de
Continuous fusing press	Maschinenfabrik Herbert Meyer GmbH	www.meyer-machines.com
Ultrasonic device	Ever Green Ultrasonic Co., Ltd.	www.evergreen-taiwan.com
	Zhejiang Huangyan Garment Machinery Factory	www.ji-feng.com
	Jesse J. Heap & Son, Inc.	www.jesseheap.com
	Perfecta Schmid Triopan AG	www.perfecta.ch
	ColDesi, Inc	www.rhinestonecamsmachines.com
	Shanghai Exing Industry Co., Ltd.	www.exingsh.com.cn
Teva	www.teva-organisation.com	
Stone setting machine	Nagel & Hermann	www.strass.cc
Applicator	Creative Crystal® Company	www.bejeweler.com
	Donwei Machinery Industry Co., Ltd.	www.donwei.com.tw
	Dreamtime Creations	www.dreamtimecreations.com
	Hobbyring	www.hobbyring.de
	Kandi Corp.	www.kandicorp.com
	Rhinestones Unlimited	www.rhinestonesu.com
Shanghai Exing Industry Co., Ltd.	www.exingsh.com.cn	
Silicone board (tool for designing Transfers) (50 x 25 x 0.1 cm, 20 x 10 x 0.05 in)	Swarovski: art. 9010/006	www.swarovski-professional.com
Teflon® foil (100 x 50 cm, 40 x 20 in)	Swarovski: art. 9010/003	www.swarovski-professional.com
Silicone ironing pad (foam) (134 x 100 cm, 54 x 40 in)	Swarovski: art. 9010/002	www.swarovski-professional.com
Silicone pad (tool for Crystal Diamond Transfers) (50 x 50 x 0.2 cm, 20 x 20 x 0.08 in)	Swarovski: art. 9010/005	www.swarovski-professional.com
Temperature measuring strips (40 pcs.)	Swarovski: art. 9010/007	www.swarovski-professional.com
Laser temperature measuring device	PCE Instruments	www.industrial-needs.com
Transfer film	DSO, Co., Ltd.	www.dso-co.com
	Nagel & Hermann	www.strass.cc

APPLICATION

BASIC HOTFIX PRINCIPLES

Hotfix elements have a coating of hot-melt glue on the back, enabling swift, simple application. This glue is activated by **heat** (applied either directly or indirectly via ultrasound), and bonds with the carrier material. When cooling, the glue hardens and

securely and permanently fixes the elements in place. The Swarovski Hotfix adhesive is characterized by its **wash resistance** and **easy-care** properties. The temperature, application time and pressure can be varied according to the

carrier material. Further details and information can be found in the "Care Instructions" chapter and in the Hotfix Selector table at the end of this chapter.

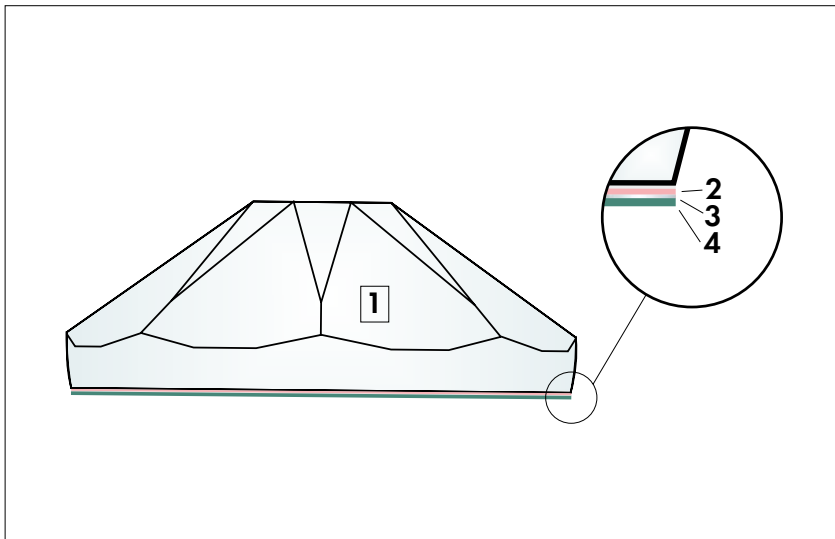

- 1 Crystal**
- 2 Silver foiling (A):** silver mirror finish (only for XIRIUS and XILION Hotfix articles) or **aluminum foiling (M):** aluminum mirror finish
- 3 Primer:** Transparent primer improves the bonding between the hot-melt adhesive and the A- or M-foiling
- 4 Hot-melt adhesive:** This transparent adhesive, developed by Swarovski, allows the application of the crystals on a variety of different materials

MATERIAL CHECK

Before beginning the application process, you should always check whether the carrier material is suitable for Hotfix application. Please check the following criteria:

- Heat resistance (min. 120 °C/250 °F)
- Resistance against pressure
- Application area of the product
- Suitability of surface properties and absorbency

CHECKING ABSORBENCY VIA THE WATER DROP TEST

The water drop test is a quick and easy way to get an initial idea of the absorbency of the carrier material.

Apply a couple of water drops onto the carrier material. If the material quickly absorbs the drops, it offers good absorbency. If the water pearls off the

carrier material, or if it takes a long time to be absorbed, the material offers insufficient absorbency. This can impair the effectiveness of Hotfix application.

APPLICATION

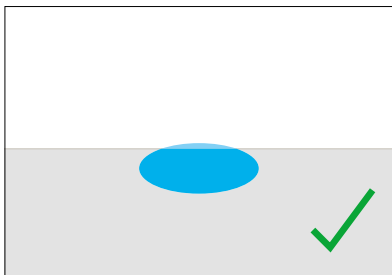

Good absorbency

Drops are absorbed

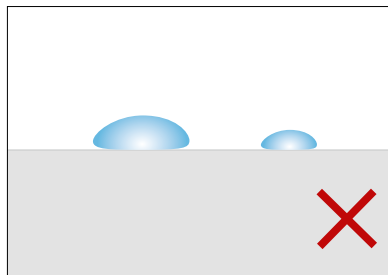

Insufficient absorbency

Drops pearl off

Some textiles and special finishes are **unsuitable** for Hotfix application, due to a **lack of absorbency**.

This is a list of **unsuitable** carrier materials and finishes:

- Very tightly woven textiles
- Very thin fabrics, e.g. tulle
- Smooth leather and smooth imitation leather
- Hydrophobic or water-repellent treatments (silicone, synthetic resin as a waterproofing agent)
- Teflon® coatings
- Stain-resistant treatments
- Easy-to-care treatments
- Fluorocarbon finishes
- Softening agents
- Select dyes (dyes with metal pigments)
- Enzymatic treatments

Note: It can sometimes be helpful to wash the carrier material before application, in order to remove any unsuitable finishes (particularly softening agents), and thus improve absorbency.

PREPARATION

Generally, the following parameters are most important when carrying out Hotfix applications of Swarovski products, depending on the consistency of the base material:

- Temperature
- Pressure
- Application time
- Application side

Note: A detailed summary of all application parameters can be found in the Hotfix Selector table at the end of this chapter.

TEMPERATURE

Swarovski Hotfix adhesive is activated within a temperature range of 120 °C to 170 °C (250 °F to 340 °F). A suitable application temperature can be selected from this range according to the carrier material and its sensitivity to heat. With heat presses, the temperature selected

on the display does not always reflect the actual temperature on the surface of the press. Often, the temperature can be distributed unevenly, or one heat plate may be defective. It is therefore recommended to regularly check the temperature with a laser

measuring device or temperature measuring strips at various points on the heating surface, to ensure the temperature is distributed evenly across it. Checks should be carried out regularly (once per week), particularly during production.

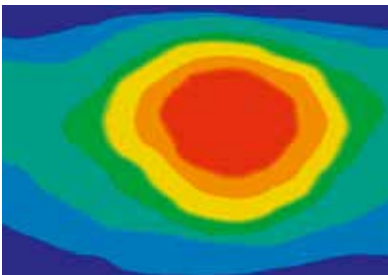

Uneven heat distribution in the central area of the heat press

■ = 120 °C (250 °F) ■ = 100 °C (212 °F)



Test with temperature measuring strips (art. 9010/007)

PRESSURE

The pressure setting depends on the Hotfix elements to be applied, the carrier material, and the technical equipment (machines, etc.) available. Too much pressure can cause the adhesive to be spread out and can also affect the

surface of the carrier material. Too little pressure, however, can result in a weak and insufficient bond between the crystal and the carrier material. In general, the pressure should be applied **directly to the crystal product** (e.g. Flat Backs Hotfix, Transfers,

Crystal Mesh). It is therefore necessary to check if there are any buttons, zippers or other raised parts surrounding them. Always use a **compensating pad** to even out the surface.



Jeans pocket

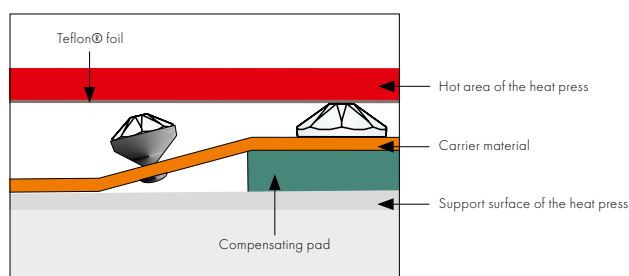

When applying Swarovski crystals of different heights, a **compensating pad** should always be used. Silicone foam, foam rubber or felt can be used here.

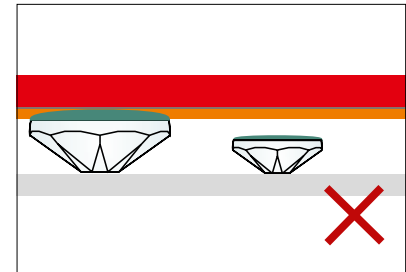
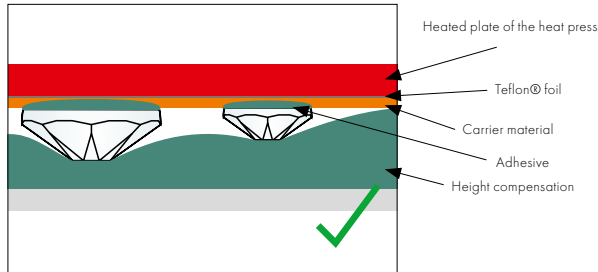

Height compensation with different Hotfix elements

The parallel plane of the heat press

Take care to apply pressure evenly when using a heat press with a scissor mechanism. The upper plate of the heat press must be

completely horizontal in order to effectively and evenly distribute pressure and temperature.

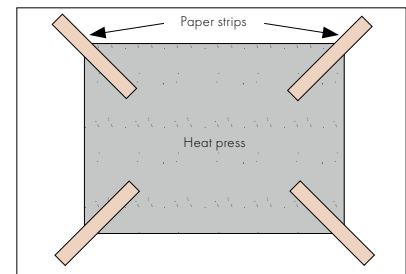
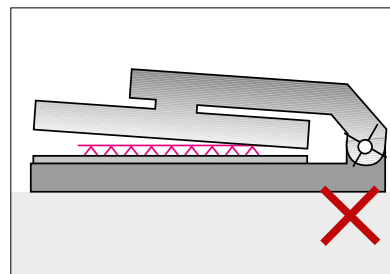
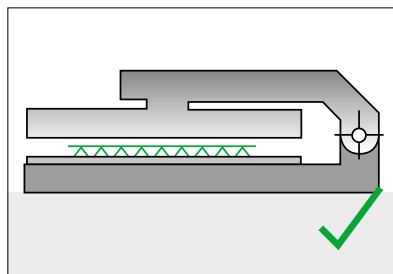

Checks should always be carried out to make sure the plates are parallel. This can be done by placing paper test strips into the press and closing it with the least possible

pressure. After this, if it takes the same force to pull out each strip, the plates are parallel.

APPLICATION TIME

In general, the application time should be sufficient to allow the hot-melt glue to be fully activated, and then to penetrate the carrier material. The application time necessarily depends on the **Hotfix elements**, the **temperature**

selected, the **machine used**, the **carrier material** and the **application side**.

A detailed summary can be found in the **Hotfix Selector table** at the end of this chapter. Please note that the times stated

are intended as a guideline. When adapting them to your application, it is recommended to carry out tests on the original material.

APPLICATION SIDE

Hotfix elements can usually be applied from the front and the back. A shorter application time can be achieved with thinner fabrics by

applying crystals from the back, as the heat reaches the adhesive through the carrier material faster, activating it immediately.

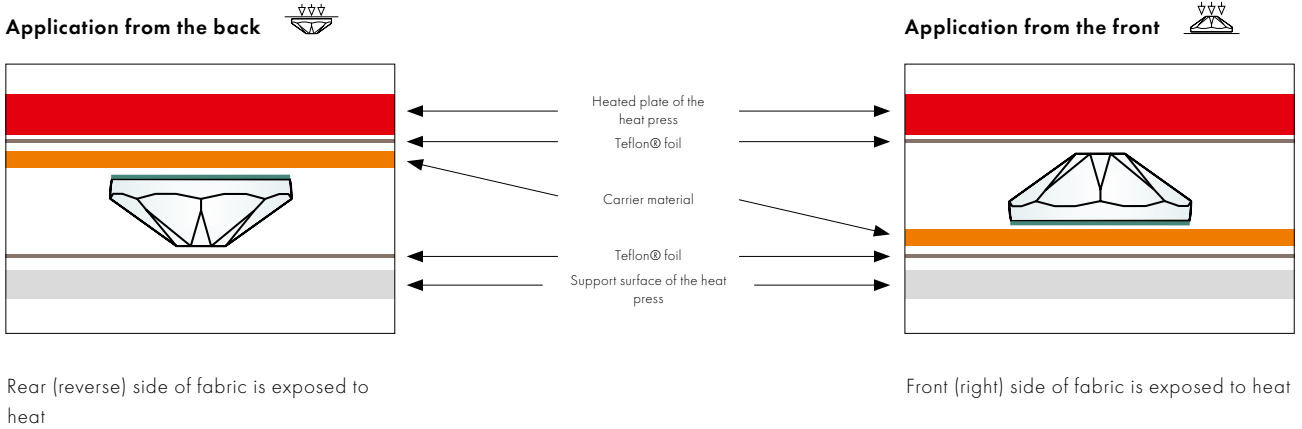

When applying Hotfix products on **thick or multi-layered** fabrics (such as seams) the application side selected should be the one

that allows the heat to be transferred to the hot-melt adhesive quickest. This ensures fast, optimum activation.

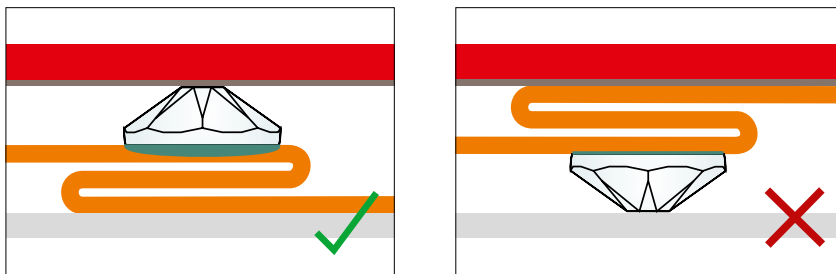

Selecting the optimum application side

Note that the shape and size (causing irregular temperature penetration) of many items (e.g. Cabochon Transfers, Creation

Transfers Plus) will only allow an application **from the back**. Further information can be

found in the Hotfix Selector table at the end of this chapter.

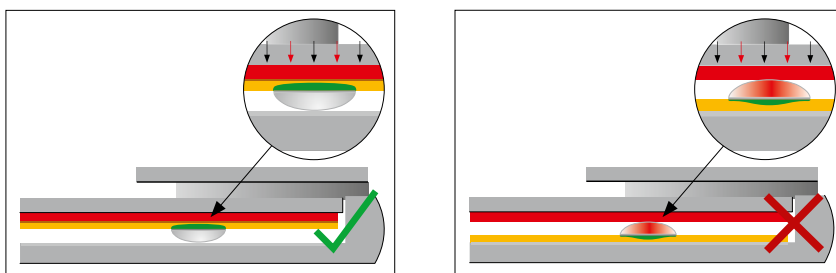

Certain Swarovski products can only be applied from the back.

DEFINING THE OPTIMUM APPLICATION PARAMETERS

Adhesive has been successfully activated when, using a magnifying glass, it is possible to see a thin edge of glue formed around the crystal. On thin fabrics, the optimum

application parameters are chosen when the glue will have lightly penetrated through the fabric and is lightly visible at the reverse.

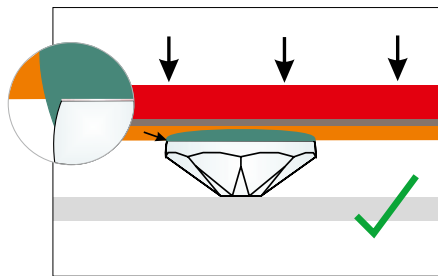

Optimum application result

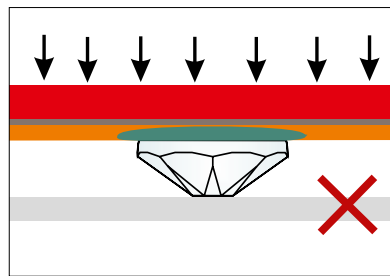

Huge excess of glue – too much pressure exerted with heat press

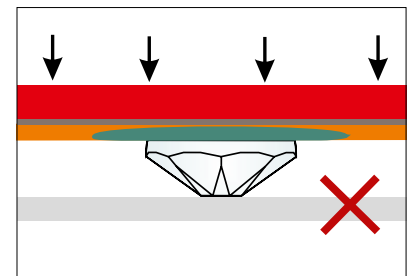

Huge excess of glue – heat press temperature too high, or applied too long

When parameters have been incorrectly selected, such as an extreme application temperature, pressure, or application time, significant amounts of glue can spread out.

When the application temperature or pressure is too low, or the application time too short, the adhesive cannot be

sufficiently activated, leading to problems with adhesion.

CRYSTAL APPLICATION INSTRUCTION MOVIE

Crystal Galuchat application

Watch instruction movie how to apply a Synthetic Hotfix product called Crystal Galuchat using a heat press online at <http://swarovski.com/hotfix-galuchat>



APPLICATION

APPLICATION USING A HEAT PRESS

A heat press is the ideal tool for applying Hoifix products as it can be used to apply even, adjustable pressure.

All Swarovski products mentioned in the product overview can be applied using the following steps. Please also note the helpful

hints concerning the application of Crystal Mesh and Crystal Diamond Transfers.

To adjust the application parameters and the tools to achieve an ideal balance, it is strongly recommended that tests are carried out with the original material.



1 Peel off the white protective film.



2 Place the product in the desired position.



3 Make sure to apply the elements from the recommended side and use the correct pressurizing medium. To protect the heating surfaces from any glue residue, it is best to cover them with Teflon® foil.



4 After pressure, time and temperature are set, close the heat press.



5 After the application is finished, use a pressing cloth to apply additional pressure to the product.



6 Once the product is at least hand warm, the transparent film can be removed at an acute angle*.

* If the adhesion is insufficient after the application process, the whole process can be repeated, adjusting the parameters (such as pressure, time, and temperature). Please ensure that the application process

is repeated from the very beginning, and that the initial application time is combined with the additional time. For example: An application time of 10 seconds was not sufficient. Pressure

should not just be applied for further 5 seconds – the process must be repeated in its entirety, with an application time of 15 seconds.

CRYSTAL APPLICATION INSTRUCTION MOVIE

Transfer Hotfix application

Watch instruction movies how to apply Hotfix products online at <http://swarovski.com/transfer-hotfix>



APPLICATION USING A CONTINUOUS FUSING PRESS

Transfers and other Hotfix Banding variants can be applied using a continuous fusing press. This type of application offers a simple, efficient way of joining the carrier material and the Hotfix product as part of a continuous application process.

With most continuous fusing presses, heat is generated on both sides. The speed of the press, pressure and temperature should be selected to ensure that the time in the heat zone corresponds to the figures in the Hotfix Selector table (see the end of this chapter).

This time can be calculated using the length of the heat zone and the speed selected.

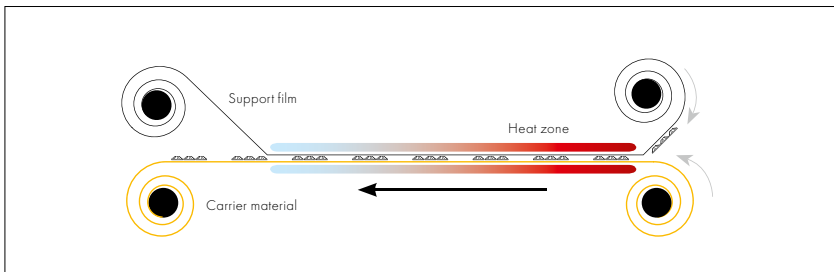

Continuous fusing press operation

APPLICATION USING AN ULTRASONIC DEVICE

Art. 2078 XIRIUS Flat Back Hotfix (SS 12 - SS 34), art. 2038 XILION Flat Back Hotfix (SS 6 - SS 10) and some Creation Stones (e.g. Rivoli cuts art. 2716, 2816, 2826) can quickly and easily be applied using an ultrasonic device. In this process, the hot-melt adhesive is activated via **friction heat**, created through the quick vibrations and simultaneous pressing down of the Flat

Backs onto the carrier material. A device with a vacuum pump is best for correctly positioning the crystals. Alternatively, they can also be positioned using transfer film or tweezers, and then applied via ultrasonic.

The frequency of the ultrasonic device must be precisely set according to the manufacturer's instructions. Some

manufacturers also offer devices with automatic frequency setting. The application time is then selected according to pretests.



1 Choose an adapter to match the size of the crystal.



2 Position the crystal on the carrier material, which should be resting on a solid base (e.g. glass, metal).



3 Press the adapter firmly onto the crystal at a perpendicular angle and activate the device.

APPLICATION USING A STONE SETTING MACHINE

Hotfix crystals can be secured with a stone setting machine using either ultrasonic or heat. The feed and application of the crystals is either fully or semi-automatic.



Stone setting machine

APPLICATION USING AN APPLICATOR

Applicators are a cost-effective way to apply art. 2078 XIRIUS Flat Back Hotfix (SS 12 - SS 34) and art. 2038 XILION Flat Back Hotfix (SS 6 - SS 10) onto the carrier material.



1 Choose an applicator point to match the size of the crystal, so that the crystal cannot tilt out of place or use a plain applicator point.



2 Heat the applicator to a suitable temperature and pick up the crystal.



3 As soon as the Hotfix adhesive on the rear of the crystal has melted, position the element on the carrier material, which should be resting on a solid base (e.g. glass, metal).

Note: Heat sensitive fabrics can be damaged by high temperatures of the applicator point.

APPLICATION USING AN IRON

In general, an iron can be used for the application of all Hotfix elements. However, as pressure and temperature can only be controlled to a **limited extent**, the use of a heat press is recommended.

Always make sure that there are no **steam vents** on the soleplate of the iron. Pressure cannot be applied at these vents, and water droplets and steam have a negative effect

on the application results. Always iron on a firm, flat, and even base.

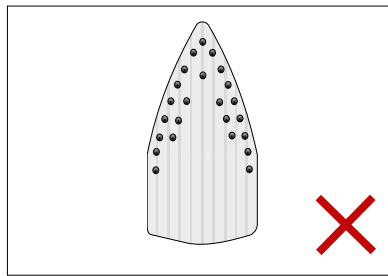
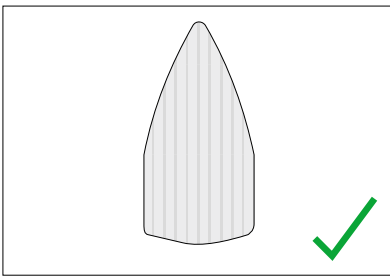

Explanation of dot system according to DIN EN ISO 3758

- Soleplate temperature 110 °C (230 °F) | •• Soleplate temperature 150 °C (302 °F) | ••• Soleplate temperature 200 °C (392 °F)



- 1 Select symbol •• (max 150 °C/ 302 °F).



- 2 Use felt or cardboard to prevent the crystal elements from marking the fabric.



- 3 A Teflon® underlay protects the soleplate of the iron from any glue residue.

FINISHING

Hot-melt adhesive generally requires **24 hours to cure completely**. Any washing

or quality assurance should take place after this period.

USEFUL INFORMATION

PRE-CUT FABRIC

Experience has shown that the best results are obtained with applications on pre-cut fabric. In order to obtain optimum adjustment of all application

parameters, advance testing on the materials to be used is strongly recommended before production begins.

CUTTING CRYSTAL MESH

Before Hotfix application, the transparent film must not be removed. The film allows the individual crystals to be aligned perfectly,

and provides Crystal Mesh with the stability necessary for flawless application.

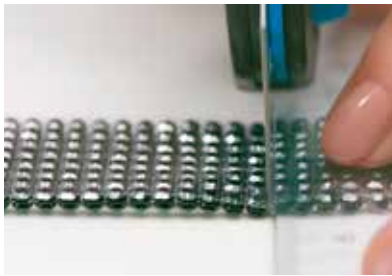

1 Cut the transparent film between the rows of crystals with a knife, but do not pull them apart, otherwise the stability of the crystals will be lost.



2 After cutting the film, there is some space between the crystal rows which allows you further processing.



3 Cut the metal mesh with a scissor along the scored line, and remove the excess link rings. The Crystal Mesh is now ready for Hotfix application.

CRYSTAL APPLICATION INSTRUCTION MOVIE

Cutting Crystal Mesh

Learn how to cut Crystal Mesh properly by watching our instruction movie online at <http://swarovski.com/cutting-crystal-mesh>



CUTTING CRYSTALTEX CHATON BANDINGS

When working with Crystaltex Chaton Bandings, the lack of space between crystals means great care must be taken

during cutting, so as to avoid damaging the crystal.

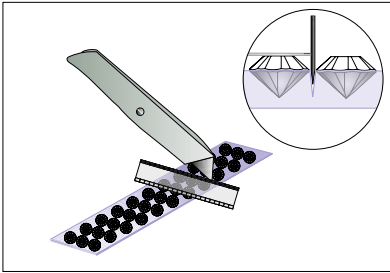

1 Cut into the support film between the crystal rows with a Stanley knife.

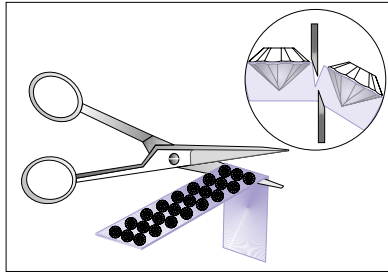

2 Snap and cut off the Crystaltex Chaton Banding along the scored edge.

AVOIDING FILM MARKS

Undesired film marks on sensitive fabrics can be avoided by cutting the transparent film close **to the edge of the motif**. Apply the product for a short time, using a

small amount of pressure. Then remove the transparent film and press again following the recommended time and pressure settings.

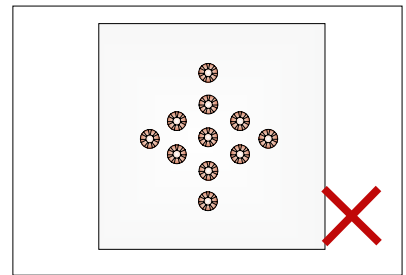
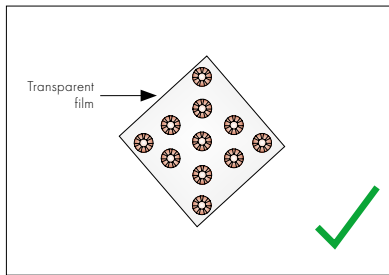

If the film has already left marks, the surface structure of the carrier material can usually be restored by brushing, using a steam iron or by re-pressing it in the heat press.

CRYSTAL APPLICATION INSTRUCTION MOVIE

Avoiding Film Marks

Learn how to properly avoid film marks by watching instruction movie online at <http://swarovski.com/avoiding-film-marks>



HOTFIX APPLICATION ON OTHER MATERIALS

The Hotfix glue was specially developed for use with textiles. However, experience shows that Hotfix applications can also be carried out on other materials such as wood, paper or metal. In such cases it is

very important to carry out application tests beforehand, and to check the surface properties (see surface tension in the "Gluing" chapter).

APPLICATION INSTRUCTIONS FOR CRYSTAL DIAMOND TRANSFERS

When applying Crystal Diamond Transfers (Transfers with high-brilliance Chatons: art. 1028 XILLION Chaton for sizes PP 7 and PP 12, art. 1088 XIRIUS Chaton for PP 17), a **soft, compensating underlay** (e.g.

silicone pad art. 9010/005) should always be used. This soft pad encloses the crystal points, and allows the optimum distribution of pressure, thus improving the bond between the carrier material and the Crystal

Diamonds (adhesion right up to the girdle). Cardboard prevents the crystals from sinking into the soft support surface of the heat press, and ensures the proper application of pressure.

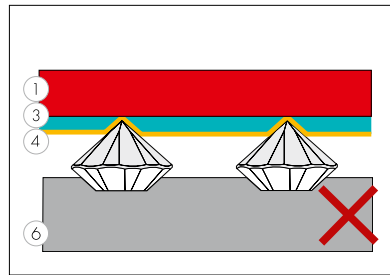
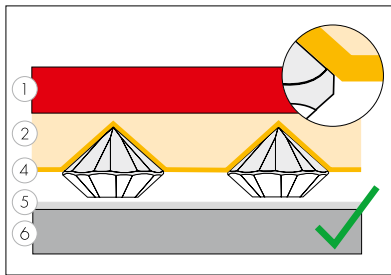

- 1 Heated surface
- 2 Silicone pad
- 3 Pressing cloth
- 4 Carrier material
- 5 Hard cardboard
- 6 Support surface of the heat press

A soft silicone pad offers optimum distribution of pressure and allows adhesion right up to the girdle.

Without a pressure compensator, adhesion only occurs at the contact points with the heated plate.

CRYSTAL DIAMOND TRANSFERS ON SOLID MATERIALS

To apply Crystal Diamond Transfers on solid, wooden-based surfaces carry out the following instructions:



1 To program the CNC milling machine with the requested Crystal Diamond motif the individual .dxf file is required. Contact your Swarovski sales office to request this file.



2 Mill the cavities using a special 90° mill with a diameter that corresponds to the selected element. Clean the surface carefully using oil-free compressed air afterwards.



3 For an easier removal of the transfer film after the application, apply a small transfer foil on the edge of the carrier material.



4 Peel off the Crystal Diamond Transfer's white protective film and place the Crystal Diamond Transfer in the desired position on the carrier material. The transfer film is lying on the small transfer foils, too.



5 Carefully clean the contact surfaces of the heat press while turned off. Position the carrier material in the heat press and set the application parameters. Make sure that the right application tools are used and the transfer is applied with low pressure.



6 After the application is finished, use a pressing cloth or a heat resistant glove to apply additional pressure.



7 Once the product has cooled down completely, the transparent film can be removed at an acute angle with help of the applied transfer foil.

We do not recommend the application of Crystal Diamond Transfer on following fields of application:

- In baths and wellness areas, due to high temperature and moisture
- In contact with sweat, chlorine and other aggressive cleaning agents
- Outdoors

For further information visit
SWAROVSKI-PROFESSIONAL.COM

Cavity production/types

Specific cavities need to be created when applying Crystal Diamond Transfers onto a carrier material with a solid surface. The cavity enables the Transfer to be easily positioned and ensures a higher protection of the crystal against

mechanical and chemical stress. These cavities can be produced by milling (e.g. with CNC machines). The individual .dxf file which is needed to program the machine includes position information (centre point of each crystal). It can be

read by standard CNC machines. For detailed information and instructions about cavity production/types please refer to the "Gluing" chapter.

ART. 1360	CAVITY ANGLE	ADDITIONAL COUNTERSINK	TWIST/ NC DRILL 90° DIAMETER
PP 7	90°	0.10 mm	1.5 mm
PP 12	90°	0.10 mm	2.0 mm
PP 17	90°	0.10 mm	2.5 mm

Application Parameters for Crystal Diamond Transfers on solid materials



APPLICATION FROM THE FRONT

	Temperature/time required (in seconds)
	110 °C
	230 °F
Medium density fiberboard (MDF)	120
Veneered wood fiberboard	120
Laminated wood fiberboard (HPL)	120
Solid hardwood	120

Pressure: low

Tools: Teflon® foil, pressing cloth, silicone ironing pad

Hotfix application of different stone sizes

A Hotfix application of one motif with different stone sizes is not possible in only one application step. In this case the specific design must be divided into separate motifs, which in turn must be applied separately, starting with the Crystal Diamond Transfers that feature the smallest stone.

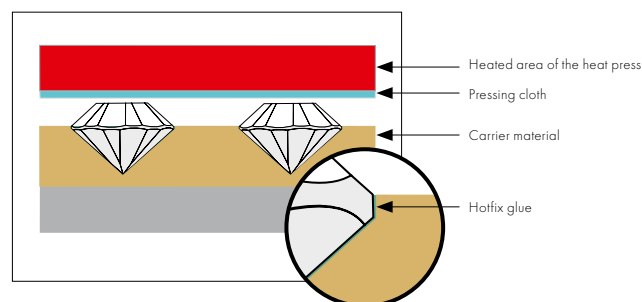

QUICK ASSISTANCE

The following table outlines typical Hotfix application problems, along with possible causes and recommendations on avoiding them.

PROBLEM	CAUSE
The product does not adhere to the fabric.	1, 2, 3, 4, 5, 6, 14
Glue is oozing out around the crystals.	7, 8, 9
The support film leaves marks on delicate fabrics.	7, 8, 9, 10, 11, 12
The product does not adhere to seams or multi-layered fabric.	1, 2, 3, 4, 5, 6, 13

CAUSE	RECOMMENDATION
1 The application temperature is too low.	Increase the temperature to at least 120 °C (250 °F). See the Hotfix Selector table for further assistance.
2 Uneven distribution of heat on the heated surface.	Check the temperature with a temperature measuring strip or a laser measuring device, and set up the heat press again.
3 The application time is too short.	Increase application time; it takes longer for the heat to activate the Hotfix glue on layered fabric and seams; if necessary apply from the front. See the Hotfix Selector table for further assistance.
4 The pressure is too low.	Thick fabrics and certain products need higher pressure. See the Hotfix Selector table for further assistance.
5 The heat press does not close evenly.	Adjust the heat press.
6 The ironing pad is unsuitable.	Carry out tests with different ironing pads to establish the most suitable.
7 The temperature is too high.	Choose a lower temperature, between 120 °C and 170 °C (250 °F - 340 °F). See the Hotfix Selector table for further assistance.
8 The application time is too long.	Reduce the application time. See the Hotfix Selector table for further assistance.
9 The pressure is too high.	Reduce the pressure on the heat press. See the Hotfix Selector table for further assistance.
10 The ironing pad is too hard.	Use a soft silicone pad.
11 The fabric is extremely sensitive.	Iron the fabric with a steam iron.
12 The transparent support film leaves marks.	Cut away more of the film, closer to the edge of the motif, to reduce marking.
13 Hotfix elements are not being affected by the heat plate.	Balance out the different thicknesses of seams, buttons, zippers etc. by using pieces of felt, which have been cut to exactly the right size and placed under the Hotfix element.
14 The carrier material is not suitable for Hotfix application.	Some textiles and special finishes are unsuitable for Hotfix application, due to a lack of absorbency (e.g. very tightly woven textiles, smooth leather and smooth imitation leather, water-repellent treatments, etc.) Swarovski Coldfix products can be an alternative solution for these special materials.

SWAROVSKI HOTFIX SELECTOR

The Hotfix Selector table contains information on the application parameters

- temperature
- pressure
- application time
- application side

for various Swarovski products and material combinations. The figures given are for Hotfix application using a heat press.

Note: The temperature/time combinations in the Hotfix Selector table are only guidelines. Too high temperature or too long application times might decrease the final bonding. Pressure cannot be specified more exactly, as this depends on the setting options of the press closure system (manual, pneumatic, hydraulic or electromagnetic). In all cases, tests should be carried out from the start of production, to ensure the ideal combination of settings for the design. The figures listed are valid until further notice.

TRANSFERS

PRODUCT	DESCRIPTION	TYPE OF SELECTOR
XILION/XIRIUS Transfers	Transfers with XILION (art. 2038) and/or XIRIUS (art. 2078) Flat Backs Hotfix	Hotfix Selector 1, page 141
Creation Transfers	Transfers combined with Creation Stones (e.g. art. 2200, 2300) or Cabochons (art. 2080/4). Stone size: max. 8 mm	Hotfix Selector 2, page 142
Mezzo Transfers	Metallic Transfers combined with XILION and/or XIRIUS Flat Backs, Cabochons or Creation Stones	Hotfix Selector 2, page 142
Cabochon Transfers	Transfers with Cabochons (art. 2080/4), Cabochons Navette (art. 2208/4), Drop (art. 2308/4, Square (art. 2408/4)**	Hotfix Selector 2, page 142
Creation Transfers Plus	Transfers combined with Creation Stones Plus (e.g. art. 2493, 2555). Stone size: > 8 mm length or > 4 mm height	Hotfix Selector 3, page 142
Crystal Diamond Transfers	Transfers with Chatons (stone size: PP 7/12/17)	Hotfix Selector 4, page 143*
Framed Flat Back Transfers	Creation Transfers with Framed Flat Backs (art. 2078/H)	Hotfix Selector 5, page 143
Framed Cabochon Transfers	Creation Transfers with Framed Cabochons (art. 2080/H)	Hotfix Selector 6, page 144

* For application on textiles. For application on solid materials please find proper application parameter at page 136.

** Please note that Cabochon Navette FB, Cabochon Drop FB, Cabochon Square FB and Pearl Cabochon FB should be applied with the Hotfix Selector 3.

SYNTHETICS

PRODUCT	DESCRIPTION	TYPE OF SELECTOR
Crystal Fabric and Graphic Fabric	Carrier material is completely covered with tiny cut and uncut crystals	Hoflix Selector 7, page 144
Crystal Rocks and Graphic Rocks	Carrier material is covered with large double-pointed Chatons (stone size: PP 22)	Hoflix Selector 8, page 145
Crystal Fine Rocks and Graphic Fine Rocks	Carrier material is covered with small double-pointed Chatons (stone size: PP 14)	Hoflix Selector 9, page 145
Crystal Ultrafine Rocks and Graphic Ultrafine Rocks	Carrier material is covered with very small double-pointed Chatons (stone size: PP 9)	Hoflix Selector 9, page 146
Crystal Galuchat	Carrier material is covered with tiny cut and uncut crystals including big crystal balls (size: 2.5 and 3.5 mm) on top	Hoflix Selector 10, page 146
Crystal Medley	Carrier material is covered with tiny cut and uncut crystals, including double-pointed Chatons (stone size: PP 14 and PP 29)	Hoflix Selector 10, page 146
Crystaltex	Differently colored carrier material with XILION Flat Backs	Hoflix Selector 11, page 146
Crystaltex Chaton	Small XILION Chatons embedded on different base materials	Hoflix Selector 7, page 144

CRYSTAL MESH

PRODUCT	DESCRIPTION	TYPE OF SELECTOR
Crystal Mesh Standard	Flexible metal mesh carrier with integrated loose crystals (stone size: PP 21)	Hoflix Selector 12, page 147
Crystal Aerial Mesh	Flexible metal mesh carrier with integrated loose crystals (stone size: PP 14)	Hoflix Selector 12, page 147
Crystal Fine Mesh	Flexible metal mesh carrier with integrated loose crystals (stone size: PP 9)	Hoflix Selector 12, page 147

FABRIC CATEGORY	FABRIC EXAMPLE	MATERIAL	WEIGHT
Reference fabric	■ Cotton/polyester blend	35% cotton, 65% polyester	210 g/m ²
Natural fibers	■ Batiste, Vichy fabric, cotton jersey, interlock, linen fabrics, etc.	Cotton, linen	100 - 200 g/m ²
	■ Silk fabrics, toile, etc.	Silk	100 - 200 g/m ²
	■ Jeans, denim, cord, velvet, damask, gabardine, sweatshirt fabrics, etc.	Cotton	300 - 400 g/m ²
Cellulose and synthetic fibers	■ Cloth, tweed, bouclé, loden, boiled wool, felt, knitted fabrics, etc.	Wool	300 - 400 g/m ²
	■ Viscose, satin, organza, chiffon, taffeta, tulle, lace, etc.	Viscose, acetate, triacetate, polyester, polyamide, polyacrylics and various fiber blends	20 - 120 g/m ²
	■ LYCRA®, neoprene, etc.		150 - 250 g/m ²
Pile fabrics	■ Artificial leather, Alcantara®, suede, fleece, artificial fur, plush, toweling, etc.	Cotton, various fiber blends	200 - 350 g/m ²

As most Swarovski products can be applied from the front or back, the Hotfix Selector table features the application parameters for both sides. Extensive information on optimum application, depending on the production process and the application type (e.g. on trouser pockets), is available.

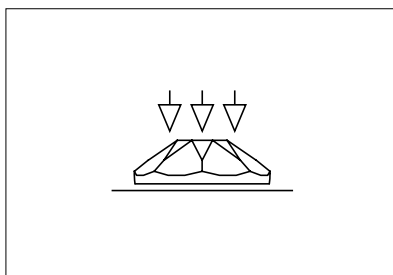

Front: The front (right side) of the fabric is exposed to the heat press.

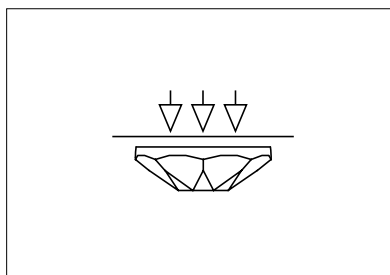

Back: The back (reverse) of the fabric is exposed to the heat press.

The temperature settings selected depend on the heat resistance of the carrier material, and should be judged by the customer. The higher the temperature, the less time is required to activate the Hotfix adhesive (see table/chart). The application time depends primarily on the textile used and its thickness.

TOOLS FOR HOTFIX APPLICATION

- Teflon® foil (100 x 50 cm, 40 x 20 in, art. 9010/003)
- Silicone ironing pad (foam) (134 x 100 cm, 54 x 40 in, art. 9010/002)
- Silicone pad (50 x 50 x 0.2 cm, 20 x 20 x 0.08 in, art. 9010/005)
- Felt
- Standard pressing cloth (cotton)
- Standard cardboard
- Transfer film (www.dso-co.com, www.strass.cc)

HOTFIX SELECTOR 1

XILION TRANSFERS / XIRUS TRANSFERS



APPLICATION FROM THE FRONT

	Temperature/time required (in seconds)					
	120 °C 250 °F	130 °C 265 °F	140 °C 285 °F	150 °C 300 °F	160 °C 320 °F	170 °C 340 °F
Cotton/polyester blend	50	42	36	30	24	18
Silk, batiste, cotton jersey, thin linen fabrics, etc.	46	38	32	26	20	15
Jeans, cord, loden, cloth, knitted fabrics, etc.	55	45	35	30	25	20
Viscose, satin, chiffon, organza, taffeta, etc.	48	40	34	28	22	16
LYCRA®, neoprene, etc.	52	44	38	32	25	18
Artificial fur, artificial leather, fleece, suede, etc.	60	50	42	34	26	20

Pressure: low
Tools: Teflon® foil, pressing cloth, silicone foam
Note: The application time depends primarily on the size of the crystal. To offer an average, figures are given for crystal size SS 20 (art. 2078).

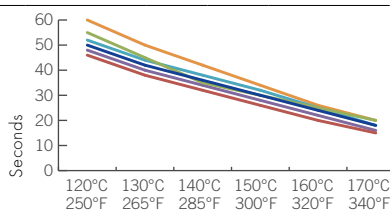

APPLICATION FROM THE BACK

	Temperature/time required (in seconds)					
	120 °C 250 °F	130 °C 265 °F	140 °C 285 °F	150 °C 300 °F	160 °C 320 °F	170 °C 340 °F
Cotton/polyester blend	20	17	14	11	8	6
Silk, batiste, cotton jersey, thin linen fabrics, etc.	15	13	11	9	7	5
Jeans, cord, loden, cloth, knitted fabrics, etc.	25	23	21	18	15	12
Viscose, satin, chiffon, organza, taffeta, etc.	12	10	8	7	6	5
LYCRA®, neoprene, etc.	35	30	25	18	13	8
Artificial fur, artificial leather, fleece, suede, etc.	50	40	35	30	25	20

Pressure: low
Tools: Teflon® foil, pressing cloth, silicone foam
Note: XIRIUS Transfers with size SS 40 and SS 48 should be applied like Creation Stones Plus (see the Swarovski Hotfix Selector overview).

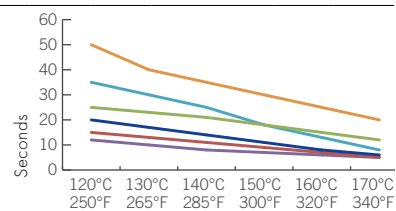

HOTFIX SELECTOR 2

CREATION TRANSFERS, MEZZO TRANSFERS & CABOCHON TRANSFERS*



APPLICATION FROM THE FRONT

	Temperature/time required (in seconds)					
	120 °C 250 °F	130 °C 265 °F	140 °C 285 °F	150 °C 300 °F	160 °C 320 °F	170 °C 340 °F
Cotton/polyester blend	55	46	40	34	28	22
Silk, batiste, cotton jersey, thin linen fabrics, etc.	50	42	36	30	24	18
Jeans, cord, loden, cloth, knitted fabrics, etc.	60	50	40	35	30	25
Viscose, satin, chiffon, organza, taffeta, etc.	52	44	38	32	26	20
LYCRA®, neoprene, etc.	58	50	42	36	30	22
Artificial fur, artificial leather, fleece, suede, etc.	62	52	45	38	30	22

Pressure: medium
Tools: Teflon® foil, pressing cloth, silicone ironing pad
Note: The application time depends primarily on the largest element in the motif.

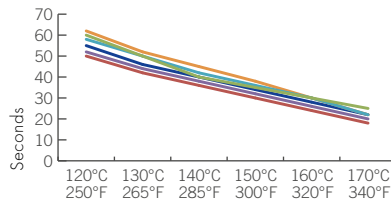

APPLICATION FROM THE BACK

	Temperature/time required (in seconds)					
	120 °C 250 °F	130 °C 265 °F	140 °C 285 °F	150 °C 300 °F	160 °C 320 °F	170 °C 340 °F
Cotton/polyester blend	25	23	19	16	12	9
Silk, batiste, cotton jersey, thin linen fabrics, etc.	27	24	20	16	12	8
Jeans, cord, loden, cloth, knitted fabrics, etc.	25	23	21	18	15	12
Viscose, satin, chiffon, organza, taffeta, etc.	18	16	14	11	8	5
LYCRA®, neoprene, etc.	38	32	26	20	15	10
Artificial fur, artificial leather, fleece, suede, etc.	55	46	40	34	28	22

Pressure: medium
Tools: Teflon® foil, pressing cloth, silicone ironing pad

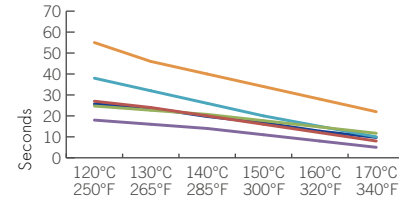

*Transfers with Cabochons (e.g. Cabochon Transfers) are NOT suitable for application from the front!

Please note that Cabochon Navette Flat Back, Cabochon Drop Flat Back, Cabochon Square Flat Back and Pearl Cabochon Flat Back should be applied with the Hotfix Selector 3.

HOTFIX SELECTOR 3

CREATION TRANSFERS PLUS



APPLICATION FROM THE FRONT

These items are NOT suitable for application from the front!



APPLICATION FROM THE BACK

	Temperature/time required (in seconds)					
	120 °C 250 °F	130 °C 265 °F	140 °C 285 °F	150 °C 300 °F	160 °C 320 °F	170 °C 340 °F
Cotton/polyester blend	35	35	30	25	18	12
Silk, batiste, cotton jersey, thin linen fabrics, etc.	35	33	30	25	20	15
Jeans, cord, loden, cloth, knitted fabrics, etc.	40	38	32	28	22	16
Viscose, satin, chiffon, organza, taffeta, etc.	28	25	22	18	12	10
LYCRA®, neoprene, etc.	38	35	30	25	18	12
Artificial fur, artificial leather, fleece, suede, etc.	57	46	40	36	30	25

Pressure: medium
Tools: Teflon® foil, pressing cloth, silicone ironing pad

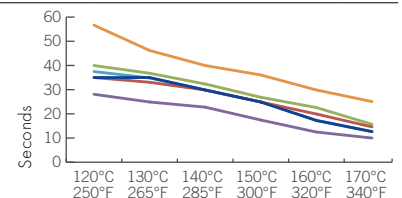

HOTFIX SELECTOR 4

CRYSTAL DIAMOND TRANSFERS



APPLICATION FROM THE FRONT

	Temperature/time required (in seconds)					
	120 °C 250 °F	130 °C 265 °F	140 °C 285 °F	150 °C 300 °F	160 °C 320 °F	170 °C 340 °F
Cotton/polyester blend	-	-	80	60	45	35
Silk, batiste, cotton jersey, thin linen fabrics, etc.	-	-	65	50	40	30
Jeans, cord, loden, cloth, knitted fabrics, etc.	-	-	65	48	35	28
Viscose, satin, chiffon, organza, taffeta, etc.	-	-	-	-	-	-
LYCRA®, neoprene, etc.	-	-	50	40	30	20
Artificial fur, artificial leather, fleece, suede, etc.	-	-	55	42	32	22

Pressure: high
Tools: Teflon® foil, pressing cloth, cardboard, preheated silicone pad
Note: Crystal Diamond Transfers are best suited to soft, voluminous fabrics.



APPLICATION FROM THE BACK

	Temperature/time required (in seconds)					
	120 °C 250 °F	130 °C 265 °F	140 °C 285 °F	150 °C 300 °F	160 °C 320 °F	170 °C 340 °F
Cotton/polyester blend	-	-	110	50	30	25
Silk, batiste, cotton jersey, thin linen fabrics, etc.	-	-	120	60	40	35
Jeans, cord, loden, cloth, knitted fabrics, etc.	-	-	110	55	35	30
Viscose, satin, chiffon, organza, taffeta, etc.	-	-	-	-	-	-
LYCRA®, neoprene, etc.	-	-	90	40	20	15
Artificial fur, artificial leather, fleece, suede, etc.	-	-	100	55	35	25

Pressure: high
Tools: Teflon® foil, pressing cloth, cardboard, preheated silicone pad
Note: Crystal Diamond Transfers are best suited to soft, voluminous fabrics.

HOTFIX SELECTOR 5

FRAMED FLAT BACK TRANSFERS



APPLICATION FROM THE FRONT

	Temperature/time required (in seconds)					
	120 °C 250 °F	130 °C 265 °F	140 °C 285 °F	150 °C 300 °F	160 °C 320 °F	170 °C 340 °F
Cotton/polyester blend	95	80	65	50	45	40
Silk, batiste, cotton jersey, thin linen fabrics, etc.	90	75	60	47	40	35
Jeans, cord, loden, cloth, knitted fabrics, etc.	95	80	65	50	45	40
Viscose, satin, chiffon, organza, taffeta, etc.	90	75	60	47	40	35
LYCRA®, neoprene, etc.	80	65	55	47	40	35
Artificial fur, artificial leather, fleece, suede, etc.	100	88	70	57	50	40

Pressure: low
Tools: Teflon® foil, pressing cloth, silicone ironing pad



APPLICATION FROM THE BACK

	Temperature/time required (in seconds)					
	120 °C 250 °F	130 °C 265 °F	140 °C 285 °F	150 °C 300 °F	160 °C 320 °F	170 °C 340 °F
Cotton/polyester blend	20	17	14	11	8	6
Silk, batiste, cotton jersey, thin linen fabrics, etc.	15	13	11	9	7	5
Jeans, cord, loden, cloth, knitted fabrics, etc.	25	23	21	18	15	12
Viscose, satin, chiffon, organza, taffeta, etc.	12	10	8	7	6	5
LYCRA®, neoprene, etc.	35	30	25	18	13	8
Artificial fur, artificial leather, fleece, suede, etc.	50	40	35	30	25	20

Pressure: low
Tools: Teflon® foil, pressing cloth, silicone ironing pad

HOTFIX SELECTOR 6

FRAMED CABOCHON TRANSFERS



APPLICATION FROM THE FRONT

These items are NOT suitable for application from the front!



APPLICATION FROM THE BACK

	Temperature/time required (in seconds)					
	120 °C 250 °F	130 °C 265 °F	140 °C 285 °F	150 °C 300 °F	160 °C 320 °F	170 °C 340 °F
Cotton/polyester blend	27	22	17	12	10	7
Silk, batiste, cotton jersey, thin linen fabrics, etc.	26	23	20	16	12	7
Jeans, cord, loden, cloth, knitted fabrics, etc.	30	27	24	20	17	14
Viscose, satin, chiffon, organza, taffeta, etc.	15	13	10	8	7	5
LYCRA®, neoprene, etc.	35	29	23	17	14	11
Artificial fur, artificial leather, fleece, suede, etc.	40	33	26	19	15	11

Pressure: low
Tools: Teflon® foil, pressing cloth, silicone ironing pad

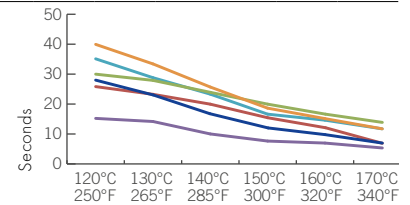

HOTFIX SELECTOR 7

CRYSTAL FABRIC, GRAPHIC FABRIC, CRYSTALTEX CHATON



APPLICATION FROM THE FRONT

	Temperature/time required (in seconds)					
	120 °C 250 °F	130 °C 265 °F	140 °C 285 °F	150 °C 300 °F	160 °C 320 °F	170 °C 340 °F
Cotton/polyester blend	-	-	50	45	40	35
Silk, batiste, cotton jersey, thin linen fabrics, etc.	-	-	45	40	35	30
Jeans, cord, loden, cloth, knitted fabrics, etc.	-	-	55	50	45	40
Viscose, satin, chiffon, organza, taffeta, etc.	-	-	35	30	25	20
LYCRA®, neoprene, etc.	-	-	40	35	30	25
Artificial fur, artificial leather, fleece, suede, etc.	-	-	38	32	27	22

Pressure: medium
Tools: Teflon® foil, pressing cloth

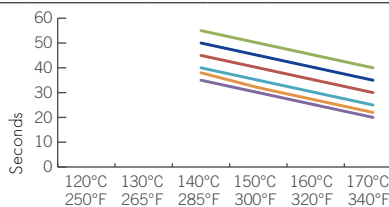

APPLICATION FROM THE BACK

	Temperature/time required (in seconds)					
	120 °C 250 °F	130 °C 265 °F	140 °C 285 °F	150 °C 300 °F	160 °C 320 °F	170 °C 340 °F
Cotton/polyester blend	-	-	50	45	40	35
Silk, batiste, cotton jersey, thin linen fabrics, etc.	-	-	45	40	35	30
Jeans, cord, loden, cloth, knitted fabrics, etc.	-	-	60	55	50	45
Viscose, satin, chiffon, organza, taffeta, etc.	-	-	35	30	25	20
LYCRA®, neoprene, etc.	-	-	45	40	35	30
Artificial fur, artificial leather, fleece, suede, etc.	-	-	42	38	32	26

Pressure: medium
Tools: Teflon® foil, pressing cloth

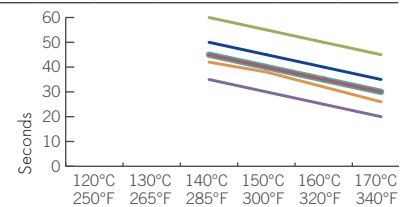

HOTFIX SELECTOR 8

CRYSTAL ROCKS & GRAPHIC ROCKS



APPLICATION FROM THE FRONT

Temperature/time required (in seconds)
120 °C 130 °C 140 °C 150 °C 160 °C 170 °C
250 °F 265 °F 285 °F 300 °F 320 °F 340 °F

Cotton/polyester blend	-	-	80	65	50	45
Silk, batiste, cotton jersey, thin linen fabrics, etc.	-	-	75	60	45	40
Jeans, cord, loden, cloth, knitted fabrics, etc.	-	-	100	80	60	50
Viscose, satin, chiffon, organza, taffeta, etc.	-	-	70	55	40	35
LYCRA®, neoprene, etc.	-	-	75	60	45	40
Artificial fur, artificial leather, fleece, suede, etc.	-	-	70	60	45	35

Pressure: medium
Tools: Teflon® foil, pressing cloth

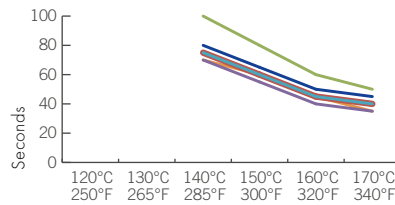

APPLICATION FROM THE BACK

Temperature/time required (in seconds)
120 °C 130 °C 140 °C 150 °C 160 °C 170 °C
250 °F 265 °F 285 °F 300 °F 320 °F 340 °F

Cotton/polyester blend	-	-	80	65	50	40
Silk, batiste, cotton jersey, thin linen fabrics, etc.	-	-	70	55	45	35
Jeans, cord, loden, cloth, knitted fabrics, etc.	-	-	100	80	60	50
Viscose, satin, chiffon, organza, taffeta, etc.	-	-	70	55	40	35
LYCRA®, neoprene, etc.	-	-	80	65	50	40
Artificial fur, artificial leather, fleece, suede, etc.	-	-	75	60	45	35

Pressure: medium
Tools: Teflon® foil, pressing cloth

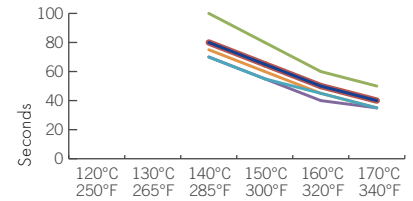

HOTFIX SELECTOR 9

CRYSTAL FINE ROCKS, GRAPHIC FINE ROCKS, CRYSTAL ULTRAFINE ROCKS & GRAPHIC ULTRAFINE ROCKS



APPLICATION FROM THE FRONT

Temperature/time required (in seconds)
120 °C 130 °C 140 °C 150 °C 160 °C 170 °C
250 °F 265 °F 285 °F 300 °F 320 °F 340 °F

Cotton/polyester blend	-	-	70	60	50	45
Silk, batiste, cotton jersey, thin linen fabrics, etc.	-	-	65	55	45	40
Jeans, cord, loden, cloth, knitted fabrics, etc.	-	-	80	70	60	50
Viscose, satin, chiffon, organza, taffeta, etc.	-	-	60	50	40	30
LYCRA®, neoprene, etc.	-	-	65	55	40	35
Artificial fur, artificial leather, fleece, suede, etc.	-	-	60	50	40	30

Pressure: medium
Tools: Teflon® foil, pressing cloth

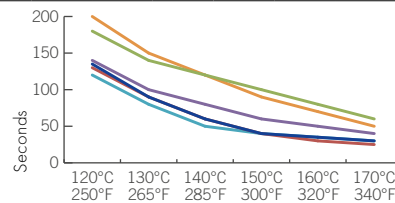

APPLICATION FROM THE BACK

Temperature/time required (in seconds)
120 °C 130 °C 140 °C 150 °C 160 °C 170 °C
250 °F 265 °F 285 °F 300 °F 320 °F 340 °F

Cotton/polyester blend	-	-	80	65	50	40
Silk, batiste, cotton jersey, thin linen fabrics, etc.	-	-	70	55	45	35
Jeans, cord, loden, cloth, knitted fabrics, etc.	-	-	100	80	60	50
Viscose, satin, chiffon, organza, taffeta, etc.	-	-	70	55	40	35
LYCRA®, neoprene, etc.	-	-	80	65	50	40
Artificial fur, artificial leather, fleece, suede, etc.	-	-	75	60	45	35

Pressure: medium
Tools: Teflon® foil, pressing cloth, transfer film to fix in place

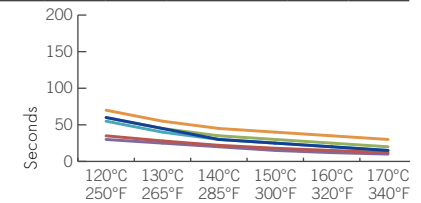

HOTFIX SELECTOR 10

CRYSTAL GALUCHAT & CRYSTAL MEDLEY*



APPLICATION FROM THE FRONT

These items are NOT suitable for application from the front!



APPLICATION FROM THE BACK

	Temperature/time required (in seconds)					
	120 °C 250 °F	130 °C 265 °F	140 °C 285 °F	150 °C 300 °F	160 °C 320 °F	170 °C 340 °F
Cotton/polyester blend	-	-	50	45	40	35
Silk, batiste, cotton jersey, thin linen fabrics, etc.	-	-	45	40	35	30
Jeans, cord, loden, cloth, knitted fabrics, etc.	-	-	60	55	50	45
Viscose, satin, chiffon, organza, taffeta, etc.	-	-	35	30	25	20
LYCRA®, neoprene, etc.	-	-	45	40	35	30
Artificial fur, artificial leather, fleece, suede, etc.	-	-	42	38	32	26

Pressure: very high
Tools: Teflon® foil,
pressing cloth,
silicone ironing pad

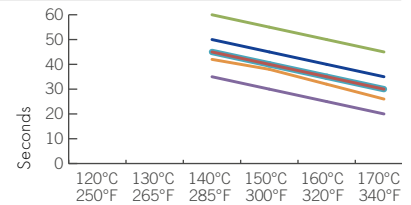

*Tests have shown that using the same parameters as for Crystal Galuchat results in a better bonding also for Crystal Medley. As a result, application from the front is no longer recommended for this product!

HOTFIX SELECTOR 11

CRYSTALTEX



APPLICATION FROM THE FRONT

	Temperature/time required (in seconds)					
	120 °C 250 °F	130 °C 265 °F	140 °C 285 °F	150 °C 300 °F	160 °C 320 °F	170 °C 340 °F
Cotton/polyester blend	40	35	30	25	20	15
Silk, batiste, cotton jersey, thin linen fabrics, etc.	42	38	32	26	22	18
Jeans, cord, loden, cloth, knitted fabrics, etc.	45	40	35	30	25	20
Viscose, satin, chiffon, organza, taffeta, etc.	42	38	32	26	22	18
LYCRA®, neoprene, etc.	40	35	30	25	20	15
Artificial fur, artificial leather, fleece, suede, etc.	45	40	35	30	25	22

Pressure: medium
Tools: Teflon® foil,
pressing cloth

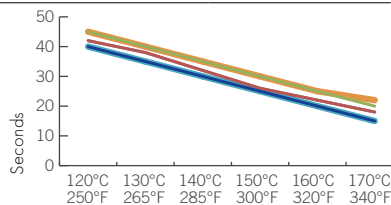

APPLICATION FROM THE BACK

	Temperature/time required (in seconds)					
	120 °C 250 °F	130 °C 265 °F	140 °C 285 °F	150 °C 300 °F	160 °C 320 °F	170 °C 340 °F
Cotton/polyester blend	30	25	20	15	12	10
Silk, batiste, cotton jersey, thin linen fabrics, etc.	35	30	25	20	15	12
Jeans, cord, loden, cloth, knitted fabrics, etc.	40	34	28	22	16	12
Viscose, satin, chiffon, organza, taffeta, etc.	20	18	16	13	11	8
LYCRA®, neoprene, etc.	28	22	18	15	12	10
Artificial fur, artificial leather, fleece, suede, etc.	42	36	30	24	18	15

Pressure: medium
Tools: Teflon® foil,
pressing cloth

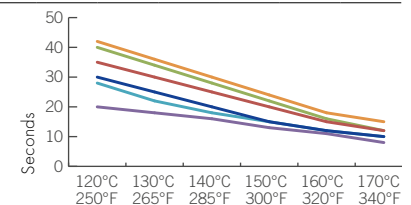

HOTFIX SELECTOR 12

CRYSTAL MESH STANDARD, CRYSTAL AERIAL MESH & CRYSTAL FINE MESH



APPLICATION FROM THE FRONT



APPLICATION FROM THE BACK

	Temperature/time required (in seconds)					
	120 °C	130 °C	140 °C	150 °C	160 °C	170 °C
	250 °F	265 °F	285 °F	300 °F	320 °F	340 °F
■ Cotton/polyester blend	135	90	60	40	35	30
■ Silk, batiste, cotton jersey, thin linen fabrics, etc.	130	90	60	40	30	25
■ Jeans, cord, loden, cloth, knitted fabrics, etc.	180	140	120	100	80	60
■ Viscose, satin, chiffon, organza, taffeta, etc.	140	100	80	60	50	40
■ LYCRA®, neoprene, etc.	120	80	50	40	35	30
■ Artificial fur, artificial leather, fleece, suede, etc.	200	150	120	90	70	50

Pressure: high
Tools: Teflon® foil, pressing cloth

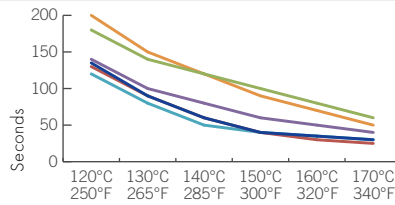

	Temperature/time required (in seconds)					
	120 °C	130 °C	140 °C	150 °C	160 °C	170 °C
	250 °F	265 °F	285 °F	300 °F	320 °F	340 °F
■ Cotton/polyester blend	60	45	30	25	20	15
■ Silk, batiste, cotton jersey, thin linen fabrics, etc.	35	28	22	18	15	12
■ Jeans, cord, loden, cloth, knitted fabrics, etc.	60	45	35	30	25	20
■ Viscose, satin, chiffon, organza, taffeta, etc.	30	25	20	15	12	10
■ LYCRA®, neoprene, etc.	55	40	30	25	20	15
■ Artificial fur, artificial leather, fleece, suede, etc.	70	55	45	40	35	30

Pressure: high
Tools: Teflon® foil, pressing cloth, transfer film to fix in place

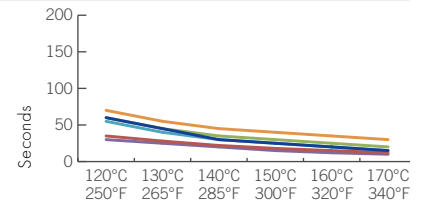



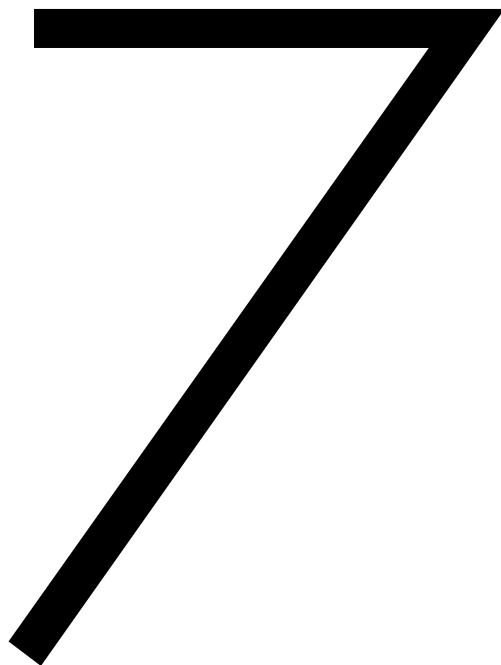

SEWING, EMBROIDERY, AND HAND APPLICATION

There are many Swarovski products that are suitable for sewing and embroidering. These products can be easily applied either by hand, or with standard domestic or industrial sewing and embroidery machines. Swarovski also offers an ideal selection of products for a variety of creative techniques by hand.

- 150** Product Overview
- 151** Machines and Tools
- 154** Suppliers
- 155** Application
- 163** Useful Information
- 165** Quick Assistance

PRODUCT OVERVIEW

The following products are suitable for sewing (by hand or machine), embroidery or hand application (e.g. beading):

	SEWING	EMBROIDERY	HAND APPLICATION TECHNIQUES
Settings	✓ ¹		✓
Beads	✓ ¹		✓
BeCharmed & Pavé	✓ ¹		✓
Crystal Pearls	✓ ¹		✓
Pendants	✓ ¹		✓
Sew-on Articles	✓	✓ ²	✓
Synthetics: Crystaltex	✓ ³		
Plastic Trimmings	✓	✓ ⁴	✓ ⁵
Crystal Buttons	✓		✓
Metal Trimmings: Flat Back Bandings	✓		
Metal Trimmings: Rose & Chaton Montées	✓ ¹		✓
Crystal Mesh	✓ ⁶		
Cupchains & Findings	✓		✓

1 These products should be sewn by hand.

2 Lochrose art. 3129

3 Not suitable for Crystaltex Chaton Bandings

4 Art. 50 002, 50 003 and 50 004 (single-row)

5 Mini Rondelles

6 Crystal Fine Mesh has a very tight structure and should therefore be sewn by hand.

MACHINES AND TOOLS

The following machines, tools and aids can be used for sewing and embroidering Swarovski products:



A **household sewing machine** offers a range of stitch types such as straight stitch, zigzag stitch and a program for sewing on buttons, and is therefore well suited to applying Swarovski products.



An **industrial sewing machine** is suitable for most sewing applications. However, a machine with a zigzag stitching program is necessary for some Swarovski products.



A **button sewer** can also be used for the application of some Swarovski Buttons.



Various **fully automatic embroidery machines** can be used for application, depending on the product.



The **lock stitch head** is ideal for applying single-row Plastic Trimmings.



Use a device like the **Laesser Crystal Stone Head** for Schifflli embroidery machines (or the **Lochrose Embroidery Device** from Tajima) to fully automatically apply Lochrose art. 3129.



Embroidery interfacing stabilizes the fabric.



Spray glue is used to fix the fabric on the interfacing.



A **frame** serves to stabilize thin and elastic fabrics during industrial embroidery processes.



Adapted presser feet/beading feet (e.g. for single-row Plastic Trimmings): standard presser feet, adapted by adding two metal plates.



By gluing on **small metal plates** (offered by Swarovski), an adapted presser foot can be made.



For zippers and products with net-edge, a **zipper foot** is helpful. A **button foot** can be used for the application of Crystal Buttons and Sew-on Articles.



Sewing and embroidery machine needles sizes Nm 70-100.



Sewing thread (Nm 50 - 80); stronger synthetic thread is more suitable for sewing on items.



It is recommended that **protective eyewear** is worn when using a sewing machine, so as to prevent injury.

ADAPTED PRESSER FOOT

To adapt a sewing machine's standard presser foot (e.g. for sewing Plastic Trimmings on garments), affix two small plates to the underside of the presser foot

with help of epoxy adhesive. Make sure that the plates are tailored to the height of the Swarovski product. When gluing, also be aware of the recommended width.

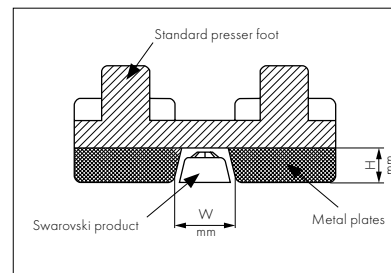

The metal plates are glued to the left and right side of the standard presser foot.

Adapted presser foot

CRYSTAL APPLICATION INSTRUCTION MOVIE

Sewing Plastic Trimmings

For detailed information regarding adaption of a standard presser foot watch Sewing instruction movie online at <http://swarovs.ki/sewing-plastic-trimmings>



AVAILABLE METAL PLATES FROM SWAROVSKI

PLASTIC TRIMMINGS	WIDTH	HEIGHT	METAL PLATES
Art. 50 002	2.7 mm	2.3 mm	art. 9040/055
Art. 50 003	3.4 mm	2.5 mm	art. 9040/056
Art. 50 004	4.4 mm	3.5 mm	art. 9040/057

SUPPLIERS

This list provides an overview of selected suppliers worldwide.

MACHINES & TOOLS	SUPPLIER	CONTACT
Sewing machines	Elna International Corp. AG Pfaff	www.elna.com www.pfaff.com
Button sewer	Pfaff	www.pfaff.com
Industrial embroidery machines (for Plastic Trimmings)	Barudan America, Inc. Meca Srl Tajima Industries Ltd. ZSK GmbH	www.barudan.com www.meca.it www.tajima.com www.zsk.de
Embroidery device for Lochrose art. 3129	Laesser AG Crystal Stone Head for Laesser embroidery machines	www.laesser.ch
	Tajima Industries Ltd. Lochrose Embroidery Device	www.tajima.com
Adapted presser foot / beading foot for sewing Plastic Trimmings	Elna International Corp. AG Pearl / Bead Foot	www.elna.com
	Pfaff Beading Foot	www.pfaff.com
Metal plates for adapting a standard presser foot	Swarovski: For Plastic Trimming art. 50 002: art. 9040/055 For Plastic Trimming art. 50 003: art. 9040/056 For Plastic Trimming art. 50 004: art. 9040/057	www.swarovski-professional.com
Machine needles	Ferd. Schmetz GmbH Groz-Beckert KG Prym	www.schmetz.com www.groz-beckert.de www.prym-consumer.com
Sewing threads	Amann & Soehne GmbH & Co. KG Coats PLC Madeira Garnfabrik KG Rayher Hobby GmbH	www.amann.com www.coats.com www.madeira.de www.rayher-hobby.de

SELECTING THE OPTIMUM
THREAD

SELECTING THE STITCH TYPE

ADJUSTING THE UPPER THREAD
TENSION

APPLICATION

APPLICATION

SELECTING THE OPTIMUM THREAD

When sewing Swarovski products, particularly Sew-on Articles, Crystal Buttons and Beads, **synthetic multifilament threads with a thread**

count of Nm 50 – 80 are most suitable. Monofilament and pure cotton yarns are not recommended due to their limited abrasion resistance.

SELECTING THE OPTIMUM
THREAD

SELECTING THE STITCH TYPE

ADJUSTING THE UPPER THREAD
TENSION

APPLICATION

SELECTING THE STITCH TYPE

In general, Swarovski products can be sewn on using a variety of stitch types.

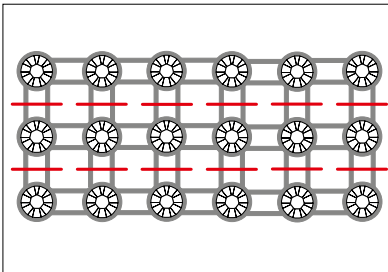

Multi-row products
Straight stitch

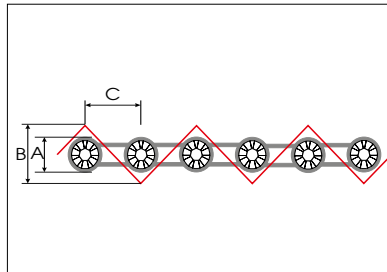

Single-row products
Zigzag stitch

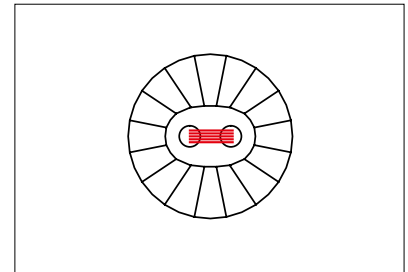

Crystal Buttons and Sew-on Articles
Button sewing program or zigzag stitch

STRAIGHT STITCH

A stitch length should be selected that allows the stitches to fall in the spaces between the cups.

ZIGZAG STITCH

The length and width of the stitch must be adjusted to suit the element being applied. The width of the stitch (B) should be 0.5 mm - 1 mm broader on both sides than the crystal product (A) being applied. The length of the stitch (C) should be equal to about 2/3 of the width of the stitch. In some cases the tension of the upper thread must be reduced.

When applying products using a zigzag stitch, the use of an adapted presser foot is recommended.

BUTTON SEWING PROGRAM

Crystal Buttons and Sew-on Articles can be applied using a button sewing program. The hole spacing must be selected in order to use the program.

ADJUSTING THE UPPER THREAD TENSION

If the upper thread tension is too tight or too loose, the resulting seam is not strong. The tension of the thread must therefore be adjusted accordingly.

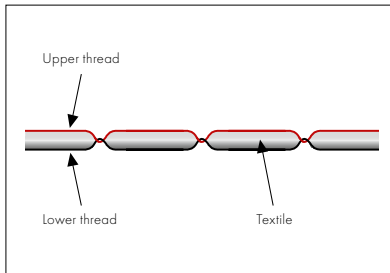

If the tension is correct, the threads cross in the middle of the textile.

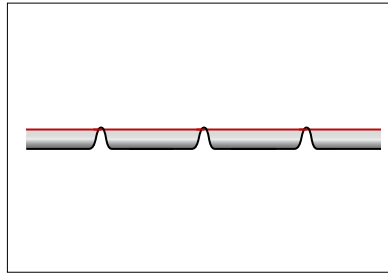

If the tension is too tight, the lower thread is visible on the upper surface of the fabric and the fabric can become gathered.

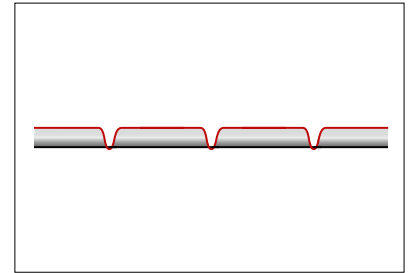

If the tension is too loose, the crossing of the threads is visible on the upper surface of the fabric.

APPLICATION

Alongside sewing by hand, the following table provides a summary of possible machine application techniques.

MACHINE APPLICATION

SWAROVSKI PRODUCTS	MACHINE	TOOL	PROGRAM	NOTE	
Sew-on Articles	Sew-on Stones	Sewing machine	Button foot	Button sewing program or zigzag stitch without feed function	Switch off the lower feed, adjust the stitch width to the product. The use of the application tool in some types of sewing machines can require some readjustment of the tension release
	Lochrose art. 3129	Schiffli embroidery machine	Laesser Crystal Stone Head or Tajima Lochrose Embroidery Device		
Synthetics	Crystaltex	Sewing machine	Standard presser foot	Straight stitch, zigzag stitch (single-row)	
Plastic Trimmings	Basic Bandings (single-row)	Sewing machine	Adapted standard presser foot	Zigzag stitch	Adjust the stitch width to the product
			Zipper foot	Straight stitch	When working with the net-edge option of the Banding
	Basic Bandings (single-row)	Embroidery machine	Lock stitch head	Zigzag stitch	
Crystal Buttons		Sewing machine	Standard presser foot	Straight stitch, zigzag stitch	Adjust the stitch width to the product
			Zipper foot	Straight stitch	When working with the net-edge option of the Banding
Metal Trimmings	Flat Back Bandings	Sewing machine	Button foot	Button sewing program or zigzag stitch without feed function	Switch off the lower feed, adjust the stitch width to the product
			Button sewer	Button sewing program	Holding clamps must be adjusted to the shape of the button
Crystal Mesh*		Sewing machine	Standard presser foot	Straight stitch	Do not remove the transparent support film before sewing, but score the film along the course of the stitching beforehand
			Zipper foot	Straight stitch	When working with the net-edge option of the Banding
Cupchains & Findings	Cupchains	Sewing machine	Adapted standard presser foot	Zigzag stitch	Adjust the stitch width to the product

* Crystal Fine Mesh has a very tight structure and should therefore be sewn by hand.

APPLICATION USING A SEWING MACHINE

The right choice of needle (strength Nm 70 - 100), sewing thread and thread tension (upper and lower thread) are particularly important for applications with a sewing machine. The fabric must not become gathered and the upper and lower thread should run easily and smoothly.

Tests should be conducted on the original material before beginning production. Before sewing on Crystal Buttons with a machine it is essential to set the sewing machine to the correct hole and stitch length, as well as stitch width. This prevents the crystal from being damaged during application and reduces the risk of injury.

When sewing high, multi-row products, there can be problems with the sewing machine feed, caused by a slanting presser foot. To avoid this, position a height compensator beneath the presser foot to ensure it sits parallel to the material, allowing the fabric to feed through properly.



The foot lies flat due to the height compensator.

A slanting presser foot can cause problems with the feed of the base material.

Sew-on Stones

Switch off the lower feed and adjust the stitch width to the product.

APPLICATION



Crystaltex Bandings

Sew between the rows of crystals.



Basic Bandings (single-row)

Make sure that the Basic Banding runs parallel to the foot.

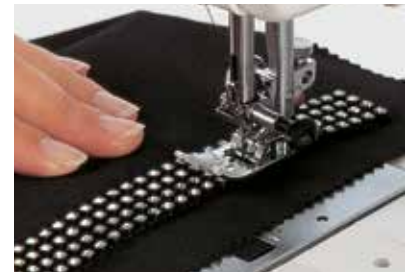

Basic Bandings (multi-row)

Stitch the Banding between the first and second rows of crystals and if necessary strengthen the corners with a zigzag stitch.

SELECTING THE OPTIMUM
THREAD

SELECTING THE STITCH TYPE

ADJUSTING THE UPPER THREAD
TENSION

APPLICATION



Crystal Buttons

Switch off the lower feed and adjust the stitch width to the product.



Flat Back Bandings

Stitch the Banding between the rows of crystals.



Crystal Mesh

Stitch the Banding between the first and second rows of crystals. Alternatively, use a zigzag stitch.

Note: Consider further details about the support film in the section Useful Information at the end of this chapter.



Cupchains

Make sure that the Cupchain runs parallel to the foot.

CRYSTAL APPLICATION INSTRUCTION MOVIE

Sewing Plastic Trimmings

Watch Sewing instruction movie online at <http://swarovski.com/sewing-plastic-trimmings>



APPLICATION USING A BUTTON SEWER

Amongst other Swarovski products, Crystal Buttons can also be applied using a button sewer.

Crystal Buttons

Before application, it is essential to set the button sewer according to the used Crystal Button. This prevents the product from being damaged during application and reduces the risk of injury.

APPLICATION USING AN EMBROIDERY MACHINE

The industrial application of single-row Plastic Trimmings and Lochrose art. 3129 can be carried out on fully automatic embroidery machines.

Plastic Trimmings



1 First design the motif. Choose the desired type of Plastic Trimming and the embroidery thread.



2 A lock stitch head can be used for applying Plastic Trimmings. It allows the Plastic Trimmings to be fixed to the carrier material by using zigzag stitch.



3 Wind the Plastic Trimming onto a suitable spool.



4 When spool and thread are in place, fix the fabric with spray glue.

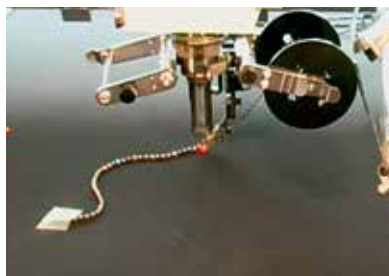

5 Start the stitching process.



6 The customized material is now ready for further processing.

SELECTING THE OPTIMUM
THREAD

SELECTING THE STITCH TYPE

ADJUSTING THE UPPER THREAD
TENSION

APPLICATION

Lochrose art. 3129

An innovative product application solution has been developed in conjunction with the companies Laesser and Tajima for the industrial application of Lochrose art. 3129 with fully automatic embroidery machines. If using a Laesser embroidery machine, the Laesser Crystal Stone Head must be

used. The application is based on standard embroidery technology and allows the unique combination of first-class Schiffl embroidery yarns (e.g. SETAFIL®) and crystal applications in a single production stage.

If sewing with a Tajima embroidery machine is preferred, the Tajima Lochrose Embroidery Device is used.



Orders for the **Lochrose art. 3129**, as well as sample and production orders, can be placed directly with your Swarovski sales partner.



1 Draw the desired motif.

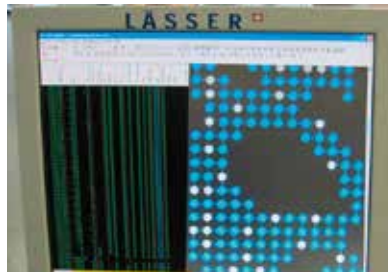

2 Enter the design into the embroidery software.



3 Fill the embroidery machine with Lochrose art. 3129.



4 Embroidery is carried out automatically using a system like the Laesser Crystal Stone Head (in the photo) or the Tajima Lochrose Embroidery Device.



5 The embroidered material is now ready for further processing.

Picture source:
S. Jurkowitsch

SELECTING THE OPTIMUM
THREAD

SELECTING THE STITCH TYPE

ADJUSTING THE UPPER THREAD
TENSION

APPLICATION

HAND APPLICATION TECHNIQUES

Some of the Swarovski products listed in the product overview at the beginning of this chapter can be applied by hand.

This means a range of creative application techniques in addition to sewing and embroidery.

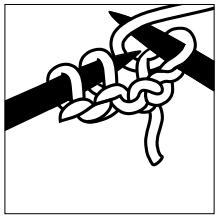

Knitting

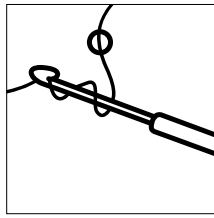

Crocheting

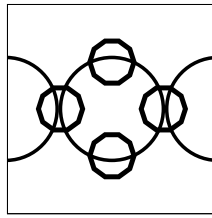

Beading

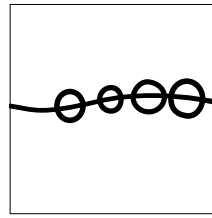

Threading

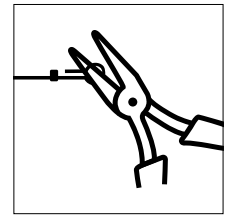

Wire working

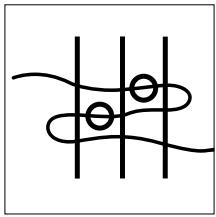

Weaving

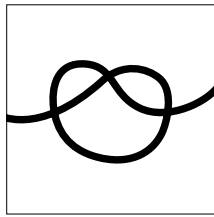

Knotting

APPLICATION & USEFUL INFORMATION

Please choose a sufficiently thick wire in accordance to the size and weight of the Swarovski crystals. For heavier products a nylon-coated wire is recommended. Crystal Pearls larger than 6 mm should be additionally knotted for a better hold.

Detailed instructions for these techniques and information concerning the necessary tools required for the work are given on CREATE-YOUR-STYLE.COM.

USEFUL INFORMATION

CUTTING AND SEWING CRYSTAL MESH

Before cutting and sewing, the transparent film must not be removed. The film allows the individual crystals to be aligned perfectly, and provides Crystal Mesh with the stability

necessary for flawless application. In case the Crystal Mesh is fixed on the fabric with Hotfix prior to sewing, the foil can be removed before starting to sew.

Cutting



1 Cut the transparent film between the rows of crystals with a knife, but do not pull them apart, otherwise the stability of the crystals will be lost.



2 After cutting the film, there is some space between the crystal rows which allows you further processing.



3 Cut the metal mesh with a scissor along the scored line, and remove the excess link rings. The Crystal Mesh is now ready for sewing.

Sewing

When sewing Crystal Mesh, it is recommended that the film is scored along the course of the stitching beforehand (see illustration).

Note: Crystal Fine Mesh cannot be sewn with a sewing machine due to its tight structure.

CRYSTAL APPLICATION INSTRUCTION MOVIE

Cutting Crystal Mesh

Learn how to cut Crystal Mesh properly by watching our instruction movie online at <http://swarovski.com/cutting-crystal-mesh>



CUTTING METAL TRIMMINGS

It is recommended that the frayed ends are removed using heat. This avoids the support fabric entering the cutting point and consequently reducing the rigidity of the product.

Alternatively, the cutting and removal can be carried out in a single process using a hot knife fabric cutter. After cutting the net the ends should be finished with flame (e.g. lighter) that the crystal cannot scale off the net.

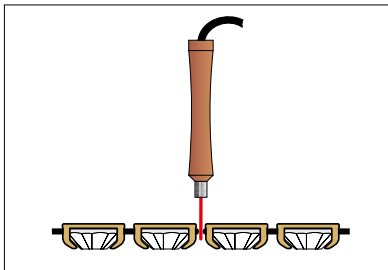

Cutting and removal of ends in a single process.

QUICK ASSISTANCE

The following table outlines typical sewing, embroidery, and hand application problems, along with possible causes and recommendations on avoiding them.

PROBLEM	CAUSE
Product or fabric is not fed through correctly.	1, 2, 3
The machine misses out stitches.	4, 5, 6, 7
The thread breaks.	4, 6, 8, 9
The needle breaks.	10, 11, 12, 13
The crystals break out of the cups.	14

CAUSE	RECOMMENDATION
1 The foot pressure may be too low.	Increase the foot pressure according to the instructions.
2 There may be dust between the feeder teeth.	Clean the feeder teeth.
3 Upper feed is faulty.	Replace the upper feed.
4 The needle may be bent or damaged.	Replace the needle.
5 The needle is not fitted correctly.	The needle must be pushed right up to the top.
6 The machine may be threaded wrongly.	Rethread the machine.
7 The tension of the threads may be incorrect.	Check the thread tension.
8 There may be knots in the thread or it may be too thin.	Check the thread for faults and if necessary, change it.
9 The components that form the stitches may be damaged.	Have the sewing machine checked by a specialist.
10 The wrong needle may have been chosen.	Choose a needle that has the correct size for the carrier material.
11 The bobbin may not be fitted correctly.	Check the bobbin case.
12 The needle is too thick and gets stuck in the product.	Use a thinner needle.
13 The needle hits the crystal.	Sew more slowly and feed the product through the machine carefully.
14 The needle damages the cup.	Check the length of the stitch and the thickness of the needle.

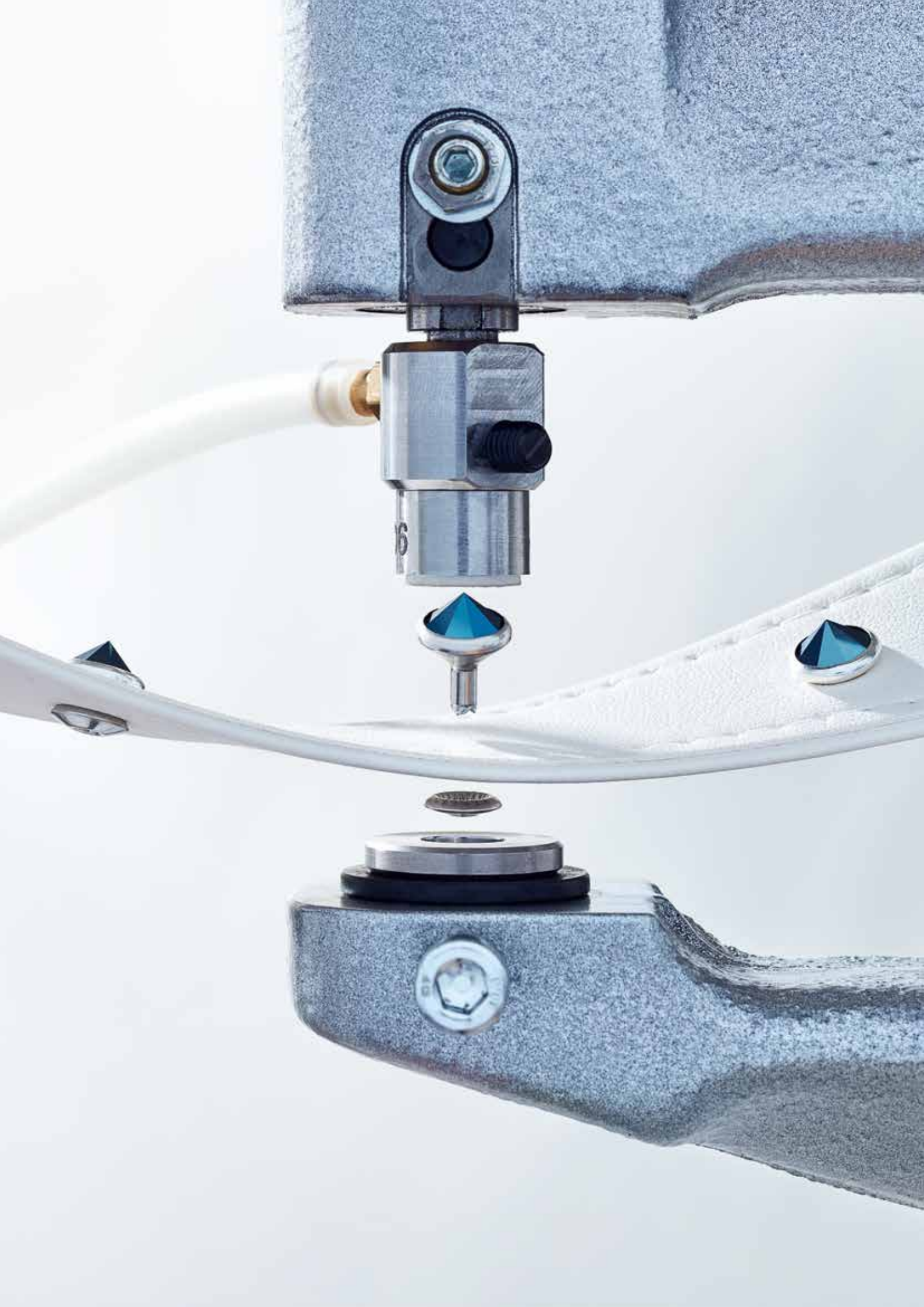

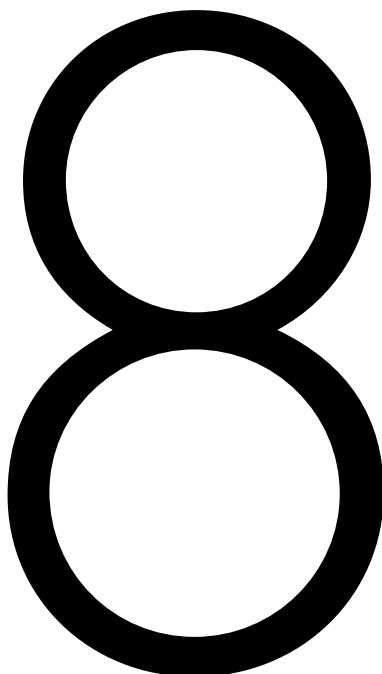

MECHANICAL APPLICATION

Many Swarovski products, such as 3D Studs, Rivets, and Rose Pins can be applied manually or mechanically, using either semi- or fully-automated machines. This simple application technique is used primarily in the textile and accessories fields.

168	Product Overview
168	Machines and Tools
175	Suppliers
179	Application
192	Useful Information
193	Quick Assistance

PRODUCT OVERVIEW

The following products are suitable for mechanical application:

METAL TRIMMINGS	MECHANICAL APPLICATION
Standard Rivets, Square Rivets, Star Rivet and Spike Rivets	✓
Rose Pins	✓
3D Studs	✓

MACHINES AND TOOLS

The following machines, tools and aids can be used for the mechanical application of Swarovski products:



The **fly press** (art. 9040/019, with mounting board) represents an easy way to mechanically apply the products.



Vacuum pump (art. 9040/022) with silicone hose allows products such as Rose Pins, 3D Studs and Rivets to be easily held in place in the fly press.



Some Swarovski products can be applied using a semi- or fully-**automatic attaching machine** (e.g. Rose Pins). In this process, the feed on the machine must be adjusted to the product being processed.



For application of Rose Pins a **Rose Pin mold** can be used (patented by Gruppo Meccaniche Luciani). Please be advised that Swarovski does not provide the tools.



3D Studs can be applied using a **3D Stud mold** (offered by Gruppo Meccaniche Luciani). Please be advised that Swarovski does not provide the tools for this mold.



It is recommended that **protective eyewear** is worn during mechanical application, to prevent injury.

Swarovski offers a variety of different tools for the fly press, depending on the product employed. The tools offered have

the following specifications: upper die (M6 screw thread), lower die (12.15 mm $+0.03/-0.10$).

If using a fly press from a provider other than Swarovski, confirm the thread sizes before ordering the tools.

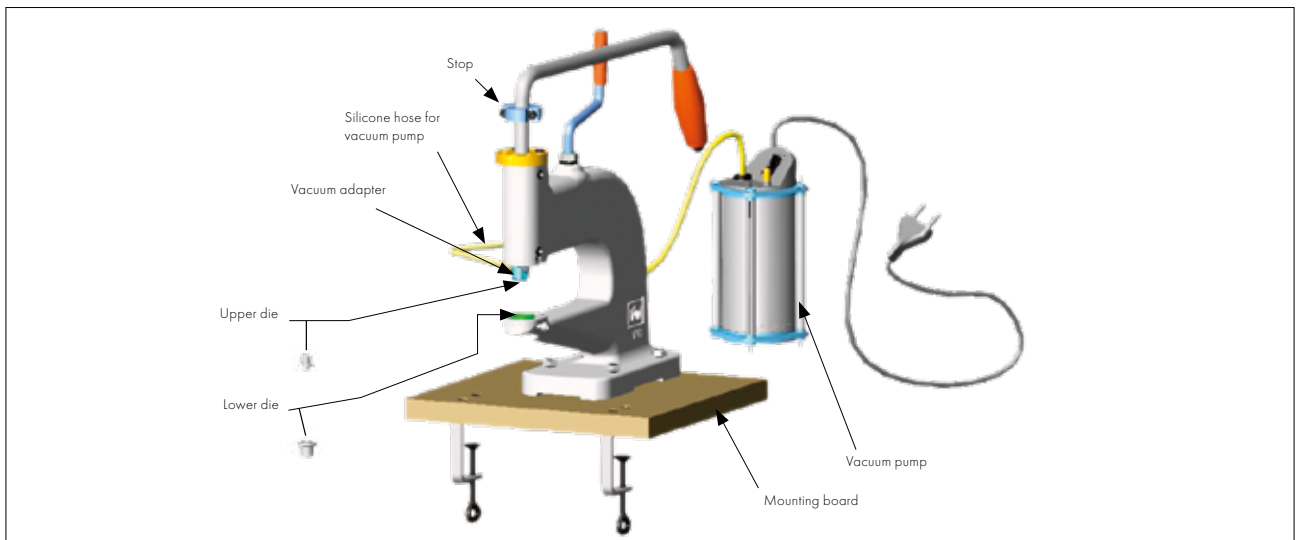

Fly press including possible dies and tools for application (in this case for the application of Rivets).

RIVETS

Rivets can be applied to various materials with or without Back Parts. The correct die combination must be chosen accordingly. Please ensure that the recommended fabric strengths, listed in the "Application"

subsection, are followed. A vacuum pump and adapter allow Rivets to be easily picked up and applied. Upper dies are thus available with different thread strengths. When using the Swarovski

vacuum adapter, dies with an M8 thread are required. Alternatively, dies with M6 threads are available for presses from other manufacturers, or when not using a vacuum adapter.

Required Application Tools	Upper Die	Vacuum Adapter ¹	Spare Part for Upper Die (insert) ²	Lower Die for application with Back Part:	Lower Die for application with Back Part:	Lower Die for application without Back Part for Rivet casing color	Lower Die for application without Back Part for Rivet casing color
							
	Art. 9040/023		Art. 9070/010	Art. 9070/012	Art. 9070/011	Art. 9040/015	

53 000



Art. 9040/005 M8	Art. 9040/023	Art. 9040/008
Art. 9040/014 M6	-	

53 001



Art. 9070/005 M8	Art. 9040/023	Art. 9070/008
Art. 9070/009 M6	-	

53 002



Art. 9040/005 M8	Art. 9040/023	Art. 9040/008
Art. 9040/014 M6	-	

53 005



Art. 9040/064 M8	Art. 9040/023	Art. 9040/062
Art. 9040/063 M6	-	



53 006

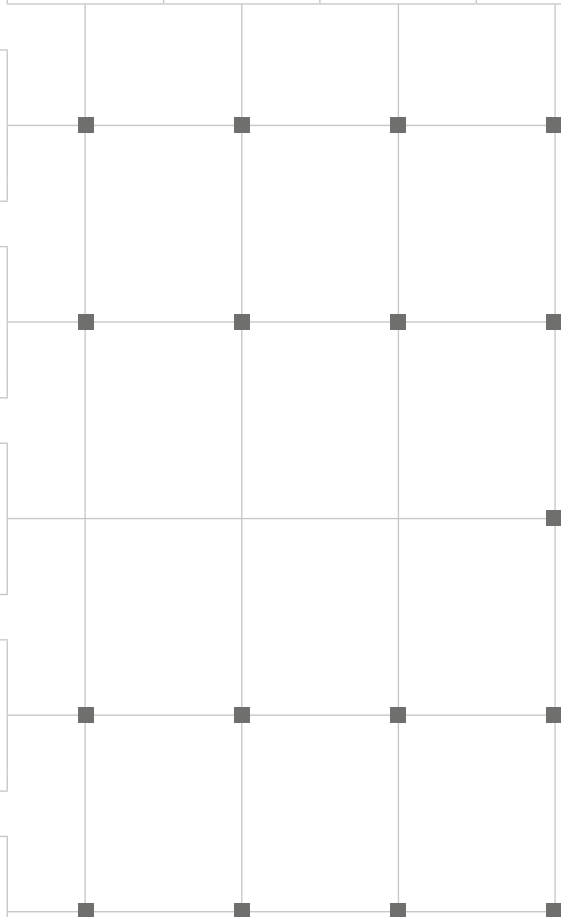

Art. 9040/067 M8	Art. 9040/023	Art. 9040/065
Art. 9040/066 M6	-	



1 When using Swarovski's fly press, tools with M8 thread and the corresponding vacuum adapter are necessary.
 2 The spare part (plastic insert) is incorporated into the upper die as standard. It should be changed when it becomes worn.

Required Application Tools	Upper Die	Vacuum Adapter ¹	Spare Part for Upper Die (insert) ²	Lower Die for application with Back Part:	Lower Die for application with Back Part:	Lower Die for application without Back Part for Rivet casing color	Lower Die for application without Back Part for Rivet casing color
						088 Stainless Steel	081 Gold
	Art. 9040/105						
				Art. 9070/010	Art. 9070/012	Art. 9070/011	Art. 9040/015

53 500



Art. 9040/106	Art. 9040/105	-
---------------	---------------	---

53 501



Art. 9040/107	Art. 9040/105	-
---------------	---------------	---

53 502

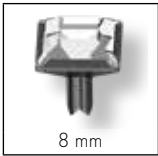

Art. 9040/108	Art. 9040/105	-
---------------	---------------	---

53 700

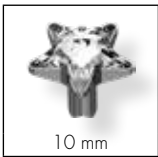

Art. 9040/112	Art. 9040/105	Art. 9040/113
---------------	---------------	---------------

53 010



Art. 9040/123	Art. 9040/105	Art. 9040/124
---------------	---------------	---------------

53 011



Art. 9040/125	Art. 9040/105	Art. 9040/126
---------------	---------------	---------------

53 503

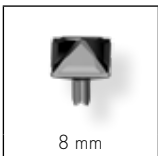

Art. 9040/127	Art. 9040/105	Art. 9040/128
---------------	---------------	---------------

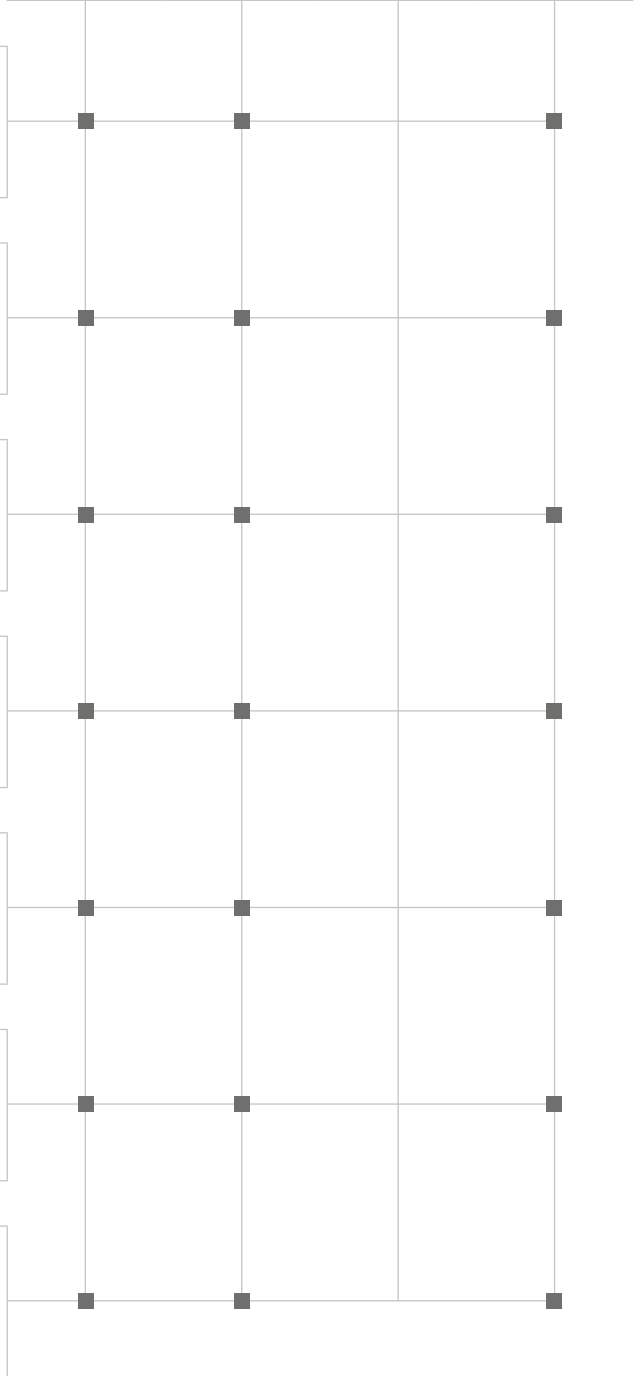

1 When using Swarovski's fly press, tools with M8 thread and the corresponding vacuum adapter are necessary.
 2 The spare part (plastic insert) is incorporated into the upper die as standard. It should be changed when it becomes worn.

Additional information vacuum adapter



Vacuum adapter (art. 9040/023) with M6 outer thread and M8 inner thread.



Vacuum adapter (art. 9040/105) with external screw instead of inner thread to fix the upper die.

ROSE PINS

A vacuum pump allows Rose Pins to be easily picked up and applied. The vacuum connection is integrated directly into the upper die. An additional vacuum adapter is not necessary.

Please note: All Rose Pin spare parts have been adapted in summer 2017. They look slightly different now while making it easier to replace the spare part in the upper die.

53 301 Rose Pin (SS 10)

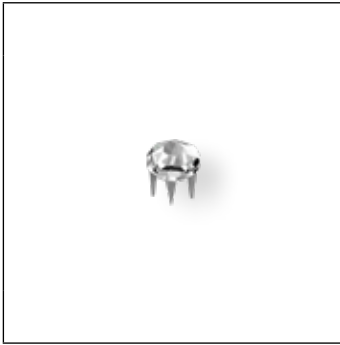

Required Application Tools	Upper Die	Spare Part ¹	Lower Die	Centering Aid ²
	Art. 9040/090 M6	Art. 9040/094	Art. 9070/013	Art. 9070/017

53 302 Rose Pin (SS 16)



Required Application Tools	Upper Die	Spare Part ¹	Lower Die
	Art. 9040/091 M6	Art. 9040/095	Art. 9070/014

53 303 Rose Pin (SS 20)



Required Application Tools	Upper Die	Spare Part ¹	Lower Die
	Art. 9040/092 M6	Art. 9040/096	Art. 9070/014

53 304 Rose Pin (SS 34)



Required Application Tools	Upper Die	Spare Part ¹	Lower Die
	Art. 9040/093 M6	Art. 9040/097	Art. 9070/016

- 1 The spare part (plastic insert) is integrated into the upper die as standard. It should be changed when it becomes worn.
- 2 The **centering aid** (art. 9070/017) for Rose Pin 53 301 allows the product to be easily positioned in the upper die.

3D STUDS

For the application with the fly press, the following tools can be used. Please consider that a vacuum pump (art. 9040/022) is

necessary to hold the Back Part in place. The vacuum connection is integrated directly into the upper die.

Required Application Tools	Upper Die	Insert	Insert	Insert	Lower Die	Linear Grid*	Changing Pin	Back Part
								
	Art. 9060/040	Art. 9060/041	Art. 9060/042	Art. 9060/043	Art. 9060/044	Art. 9060/045	Art. 9060/015	Art. 54 004

54 001

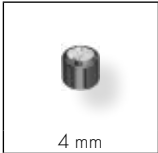

54 002

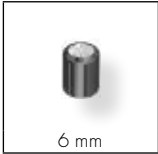

54 003

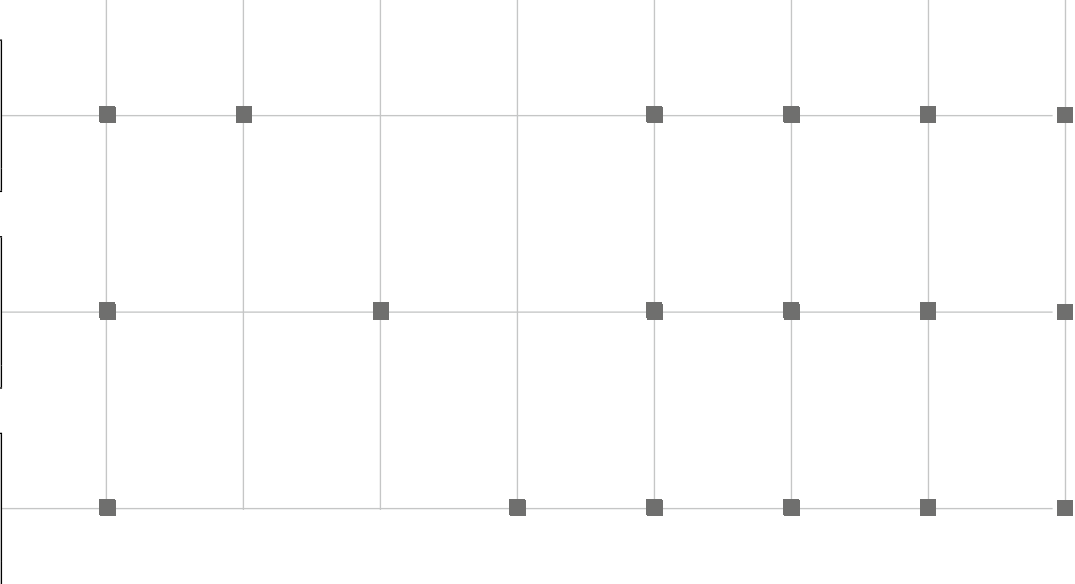

* Optional tool for the even/linear application of more than one 3D Stud.

SUPPLIERS

This list provides an overview of selected suppliers worldwide.

MACHINES & TOOLS	SUPPLIER	CONTACT
Fly press	Swarovski:	www.swarovski-professional.com
	Fly press without mounting board: art. 9040/017	
	Fly press with mounting board: art. 9040/019	
Tools for Rivets (fly press)	Jiuzhou Machinery Co., Ltd.	www.sinojiuzhou.com
	Seung Min Industrial Co., Ltd.	www.seungminsm.co.kr
	Standard Rivet Company	www.standardrivet.com
Tools for Rivets (fly press)	Swarovski:	www.swarovski-professional.com
	Rivet 53 000	
	Upper die (M8): art. 9040/005 Upper die (M6): art. 9040/014 Spare part (plastic insert) for upper die (art. 9040/005 and 9040/014): art. 9040/008 Lower die for Rivet application with Back Part 53 007: art. 9070/010 Lower die for Rivet application with Back Part 53 009: art. 9070/012 Lower die for Rivet application without Back Part (Rivet casing 081, 082 and 086): art. 9040/015 Lower die for Rivet application without Back Part (Rivet casing 088): art. 9070/011 Vacuum adapter for upper die (art. 9040/005): art. 9040/023	
Tools for Rivets (fly press)	Rivet 53 001	www.swarovski-professional.com
	Upper die (M8): art. 9070/005 Upper die (M6): art. 9070/009 Spare part (plastic insert) for upper die (art. 9070/005 and 9070/009): art. 9070/008 Lower die for Rivet application with Back Part 53 007: art. 9070/010 Lower die for Rivet application with Back Part 53 009: art. 9070/012 Lower die for Rivet application without Back Part (Rivet casing 081, 082 and 086): art. 9040/015 Lower die for Rivet application without Back Part (Rivet casing 088): art. 9070/011 Vacuum adapter for upper die (art. 9070/005): art. 9040/023	
	Rivet 53 002	
Tools for Rivets (fly press)	Upper die (M8): art. 9040/005 Upper die (M6): art. 9040/014 Spare part (plastic insert) for upper die (art. 9040/005 and 9040/014): art. 9040/008 Lower die for Rivet application without Back Part (Rivet casing 081, 082 and 086): art. 9040/015 Vacuum adapter for upper die (art. 9040/005): art. 9040/023	www.swarovski-professional.com
	Rivet 53 005	
	Upper die (M8): art. 9040/064 Upper die (M6): art. 9040/063 Spare part (plastic insert) for upper die (art. 9040/064 and 9040/063): art. 9040/062 Lower die for Rivet application with Back Part 53 007: art. 9070/010 Lower die for Rivet application with Back Part 53 009: art. 9070/012 Lower die for Rivet application without Back Part (Rivet casing 081, 082 and 086): art. 9040/015 Lower die for Rivet application without Back Part (Rivet casing 088): art. 9070/011 Vacuum adapter for upper die (art. 9040/064): art. 9040/023	

MACHINES & TOOLS	SUPPLIER	CONTACT
	<p>Rivet 53 006 Upper die (M8): art. 9040/067 Upper die (M6): art. 9040/066 Spare part (plastic insert) for upper die (art. 9040/067 and 9040/066): art. 9040/065 Lower die for Rivet application with Back Part 53 007: art. 9070/010 Lower die for Rivet application with Back Part 53 009: art. 9070/012 Lower die for Rivet application without Back Part (Rivet casing 081, 082 and 086): art. 9040/015 Lower die for Rivet application without Back Part (Rivet casing 088): art. 9070/011 Vacuum adapter for upper die (art. 9040/067): art. 9040/023</p>	
Tools for Square Rivets (fly press)	<p>Swarovski: Square Rivet 53 500 Upper die: art. 9040/106 Lower die for Rivet application with Back Part 53 007: art. 9070/010 Lower die for Rivet application with Back Part 53 009: art. 9070/012 Lower die for Rivet application without Back Part (Rivet casing 081, 082 and 086): art. 9040/015 Vacuum adapter for upper die: art. 9040/105</p> <p>Square Rivet 53 501 Upper die: art. 9040/107 Lower die for Rivet application with Back Part 53 007: art. 9070/010 Lower die for Rivet application with Back Part 53 009: art. 9070/012 Lower die for Rivet application without Back Part (Rivet casing 081, 082 and 086): art. 9040/015 Vacuum adapter for upper die: art. 9040/105</p> <p>Square Rivet 53 502 Upper die: art. 9040/108 Lower die for Rivet application with Back Part 53 007: art. 9070/010 Lower die for Rivet application with Back Part 53 009: art. 9070/012 Lower die for Rivet application without Back Part (Rivet casing 081, 082 and 086): art. 9040/015 Vacuum adapter for upper die: art. 9040/105</p>	www.swarovski-professional.com
Tools for Star Rivets (fly press)	<p>Swarovski: Star Rivet 53 700 Upper die: art. 9040/112 Spare part (plastic insert) for upper die (art. 9040/112): art. 9040/113 Lower die for Rivet application with Back Part 53 007: art. 9070/010 Lower die for Rivet application with Back Part 53 009: art. 9070/012 Lower die for Rivet application without Back Part (Rivet casing 081, 082 and 086): art. 9040/015 Vacuum adapter for upper die: art. 9040/105</p>	www.swarovski-professional.com
Tools for Spike Rivets (fly press)	<p>Swarovski: Spike Rivet 53 010 Upper die: art. 9040/123 Spare part (plastic insert) for upper die (art. 9040/123): art. 9040/124 Lower die for Rivet application with Back Part 53 007: art. 9070/010 Lower die for Rivet application with Back Part 53 009: art. 9070/012 Lower die for Rivet application without Back Part (Rivet casing 081, 082 and 086): art. 9040/015 Vacuum adapter for upper die: art. 9040/105</p>	www.swarovski-professional.com

MACHINES & TOOLS	SUPPLIER	CONTACT
	<p>Spike Rivet 53 011 Upper die: art. 9040/125 Spare part (plastic insert) for upper die (art. 9040/125): art. 9040/126 Lower die for Rivet application with Back Part 53 007: art. 9070/010 Lower die for Rivet application with Back Part 53 009: art. 9070/012 Lower die for Rivet application without Back Part (Rivet casing 081, 082 and 086): art. 9040/015 Vacuum adapter for upper die: art. 9040/105</p> <p>Spike Rivet 53 503 Upper die: art. 9040/127 Spare part (plastic insert) for upper die (art. 9040/127): art. 9040/128 Lower die for Rivet application with Back Part 53 007: art. 9070/010 Lower die for Rivet application with Back Part 53 009: art. 9070/012 Lower die for Rivet application without Back Part (Rivet casing 081, 082 and 086): art. 9040/015 Vacuum adapter for upper die: art. 9040/105</p>	
Tools for Rose Pins (fly press)	<p>Swarovski:</p> <p>Rose Pin 53 301 Upper die (M6): art. 9040/090 Spare part (plastic insert) for upper die (art. 9040/090): art. 9040/094 Lower die: art. 9070/013 Centering aid: art. 9070/017</p> <p>Rose Pin 53 302 Upper die (M6): art. 9040/091 Spare part (plastic insert) for upper die (art. 9040/091): art. 9040/095 Lower die: art. 9070/014</p> <p>Rose Pin 53 303 Upper die (M6): art. 9040/092 Spare part (plastic insert) for upper die (art. 9040/092): art. 9040/096 Lower die: art. 9070/014</p> <p>Rose Pin 53 304 Upper die (M6): art. 9040/093 Spare part (plastic insert) for upper die (art. 9040/093): art. 9040/097 Lower die: art. 9070/016</p>	www.swarovski-professional.com
Tools for 3D Studs (fly press)	<p>Swarovski:</p> <p>3D Stud 54 001 Upper die for Back Part 54 004: art. 9060/040 Insert: art. 9060/041 Lower die: art. 9060/044 Linear grid: art. 9060/045 Changing pin: art. 9060/015</p> <p>3D Stud 54 002 Upper die for Back Part 54 004: art. 9060/040 Insert: art. 9060/042 Lower die: art. 9060/044 Linear grid: art. 9060/045 Changing pin: art. 9060/015</p>	www.swarovski-professional.com

MACHINES & TOOLS	SUPPLIER	CONTACT
	3D Stud 54 003 Upper die for Back Part 54 004: art. 9060/040 Insert: art. 9060/043 Lower die: art. 9060/044 Linear grid: art. 9060/045 Changing pin: art. 9060/015	
Vacuum pump with silicone hose	Swarovski: art. 9040/022	www.swarovski-professional.com
Automatic attaching machine	Jiuzhou Machinery Co., Ltd. Pym Fashion GmbH Seung Min Industrial Co., Ltd. Sagitta SPA	www.sinojiuzhou.com www.pym-fashion.com www.seungminsm.co.kr www.sagitta.it
Rose Pin mold	Gruppo Meccaniche Luciani Srl	www.gruppomeccanicheluciani.com
3D Stud mold	Gruppo Meccaniche Luciani Srl	www.gruppomeccanicheluciani.com

APPLICATION

Various Swarovski products can be applied using mechanical force, creating a lasting bond with the carrier material.

CHECKING MATERIAL STRENGTH

PRODUCT-SPECIFIC APPLICATION

CHECKING MATERIAL STRENGTH

It is important to carefully check the thickness of the fabric or leather before beginning the application process. With very thick fabrics, a hole can be punched beforehand for the application of Rivets. The fabric should not crinkle or become

gathered after application. To check this, carry out tests on fabric or leather scraps before going ahead with the application process. It is also important to make sure that the die sits straight and firmly in the fly press, as this can often cause application

problems. It is recommended that you carry out a few test runs to identify the ideal pressure. The offset/pressure can be regulated using an adjustable stop that is fastened to the handle of the fly press.

CHECKING MATERIAL STRENGTH

PRODUCT-SPECIFIC APPLICATION

PRODUCT-SPECIFIC APPLICATION

Before starting, make sure the fly press is aligned and upper and lower dies are arranged along an axis. Dies should be clean, polished and intact.

By carrying out pre-application tests, contracted or crinkled material after the application can be avoided, as well as too much space between fabric and pieces.

In order to prevent possible injury, the wearing of protective eyewear is recommended when mechanically applying crystal products.

RIVETS

For the application of Rivets, use a fly press or a semi-automatic attaching machine: The following instructions focus on the application with the fly press. As a first step, attach the appropriate die to the fly press. Rivets can be applied on various materials

with or without Back Parts. Rivet 53 002 is specially designed for application without a Back Part. For applications on leather, Stainless Steel Rivets (color code 088) and Back Parts are recommended.

Please note the material thickness when selecting Rivets. The dies should be selected accordingly.

	ART.	SIZE	MATERIAL THICKNESS*	POSSIBLE BACK PARTS
RIVETS	53 000	SS 18	2.0 - 2.5 mm	53 007 and 53 009
	53 001	SS 29	2.0 - 2.5 mm	53 007 and 53 009
	53 002	SS 18	1.5 - 2.0 mm	
	53 005	SS 34	2.0 - 2.5 mm	53 007 and 53 009
	53 006	SS 39	2.2 - 2.7 mm	53 007 and 53 009
SQUARE RIVETS	53 500	4 mm	2.0 - 2.5 mm	53 007 and 53 009
	53 501	6 mm	2.0 - 2.5 mm	53 007 and 53 009
	53 502	8 mm	2.2 - 2.7 mm	53 007 and 53 009
STAR RIVET	53 700	10 mm	1.5 - 3.0 mm	53 007 and 53 009
SPIKE RIVETS	53 010	SS 29	2.0 - 3.0 mm	53 007 and 53 009
	53 011	SS 39	2.0 - 3.0 mm	53 007 and 53 009
	53 503	8 mm	2.0 - 3.0 mm	53 007 and 53 009

* This can vary according to the roughness and production of the carrier material.

Application with a fly press

In many cases it is possible to select between both versions of the Back Parts.

For applications on **thinner fabrics**, it is better to use the **larger** Back Part (art. 53 007). Its size means this Back Part

can better hold the split Rivet shaft, avoiding any damage to the crystal.

For **multi-layered or thicker** materials, the smaller Back Part (art. 53 009) can be used.

To create a lasting bond, this requires less space for the split Rivet shaft. If the carrier material proves too thick, or is made up of several layers, it is recommended to punch a hole before application.

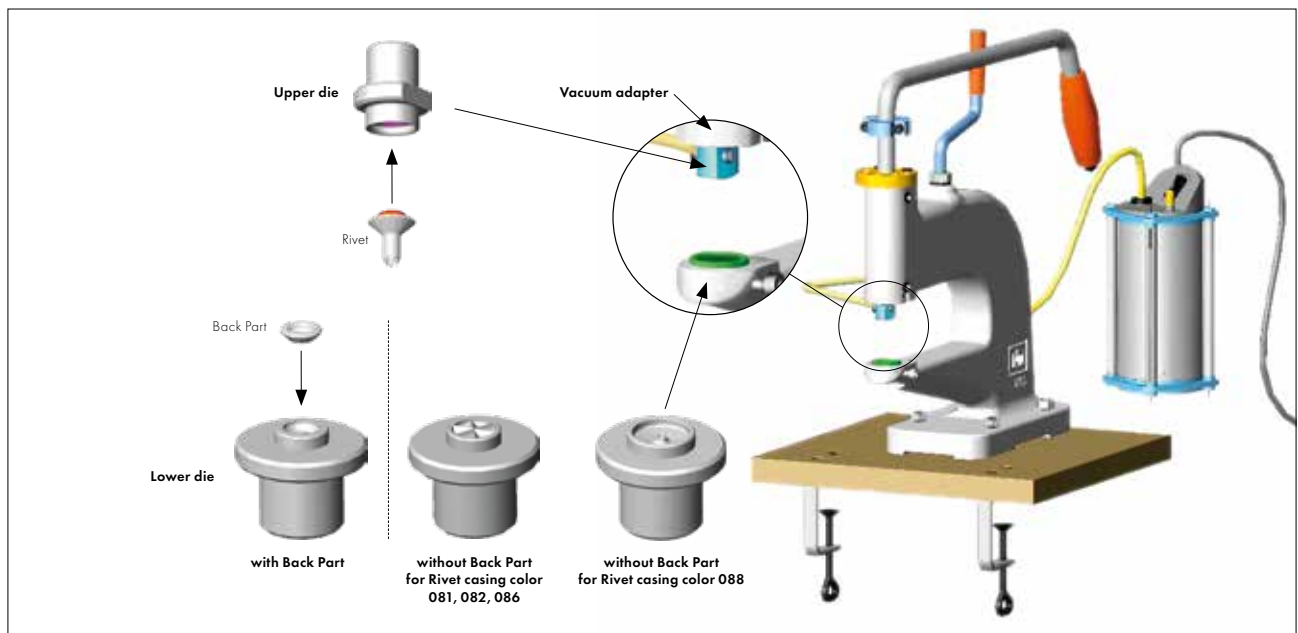

CRYSTAL APPLICATION INSTRUCTION MOVIE

Rivets - Application with a fly press

Learn how to properly apply Rivets using a fly press by watching instruction movie online at <http://swarovski.com/rivets-fly-press>



ROSE PINS

Pins can be easily applied using a fly press, a semi- or fully-automated attaching machine. The application with the fly press

will be explained step by step. Please note the material thickness when selecting Pins.

	ART.	SIZE	MATERIAL THICKNESS*
ROSE PINS	53 301	SS 10	1 - 2 mm
	53 302	SS 16	1 - 2 mm
	53 303	SS 20	1 - 2 mm
	53 304	SS 34	1 - 2 mm

* This can vary according to the roughness and production of the carrier material.

Application with a fly press

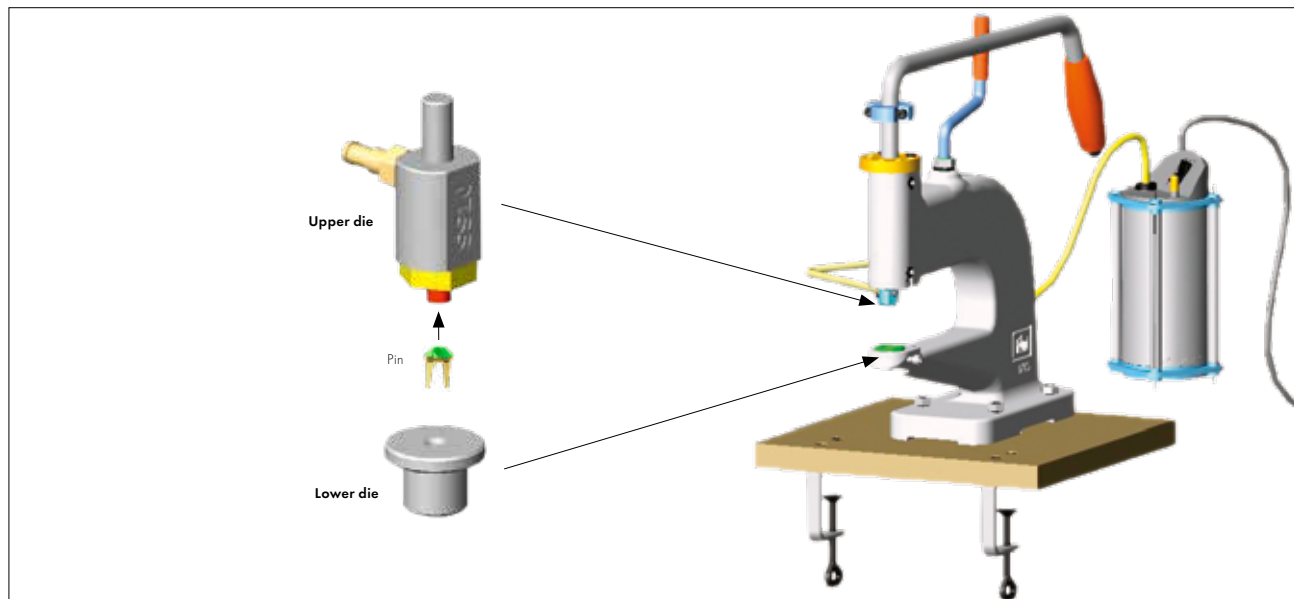

To apply Pins, attach the appropriate die to the fly press.



1 Place the Pin in the upper die.



2 Position the carrier material and apply. Regulate the offset/pressure using the adjustable stop.

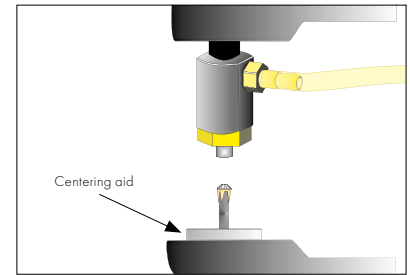

To facilitate the positioning of the small Rose Pin (art. 53 301, SS 10) in the upper die, the centering aid can be used. The tool must be removed before applying the Rose Pin.

Note: Do not apply Pins on areas of the carrier material that are under high mechanical stress, such as critical parts of a shoe. After application, ensure the Pins are not heated up to more than 80 °C (176 °F).

CRYSTAL APPLICATION INSTRUCTION MOVIE

Rose Pins - Application with a fly press

Learn how to properly apply Rose Pins using a fly press by watching the corresponding instruction movie online at <http://swarovski.com/rose-pins-fly-press>



Application with a Rose Pin mold

To apply Rose Pins a Rose Pin mold (patented by Gruppo Meccaniche Luciani) can be used. Therefore Rose Pins are sieved into cavities of the lower part of the mold by

using PVC masks specific for each diameter/design. In a next step base material is put into the mold. By closing mold and adding pressure by using a hydraulic press

Rose Pins are applied onto base material simultaneously in one step.



1 Place the first PVC mask onto the lower part of the mold.



2 Sieve Rose Pins into the mask with the claws pointing upwards. Use one mask for each Rose Pin size and repeat the sieving step with all masks.



3 After having sieved all Rose Pins into the mold, remove the masks.



4 Put the fabric onto the lower part of the mold. Right site of fabric is facing down.



5 Close the mold and place it in a hydraulic press.



6 Press the mold with the hydraulic press.



7 After pressing, open the mold and remove the fabric with the applied Rose Pins.

CRYSTAL APPLICATION INSTRUCTION MOVIE

Rose Pins - Application with a Rose Pin mold

Learn how to apply many Rose Pins simultaneously using a mold by watching our instruction movie online at <http://swarovski.com/rose-pins-mold-press>



3D STUDS

This product can be applied on different carrier materials using either a fly press or a 3D Stud mold. Application tests on your carrier material of choice – especially

stretchable fabrics – are recommended. Before applying 3D Studs to any leather or fabric, please also test the metal- and especially silver compatibility with the

corresponding carrier material. Please consider the material thickness before starting the application.

	ART.	LENGTH OF SHANK	MATERIAL THICKNESS*
3D STUDS	54 001	4 mm	0.7 - 1.5 mm
	54 002	6 mm	0.7 - 1.5 mm
	54 003	8 mm	0.7 - 1.5 mm

* This can vary according to the roughness and production of the carrier material.

Application with a fly press

First, position the upper and lower die in the press. Make sure to choose the corresponding insert for the 3D Stud to be

applied, and position it in the lower die with the cavity pointing upwards:

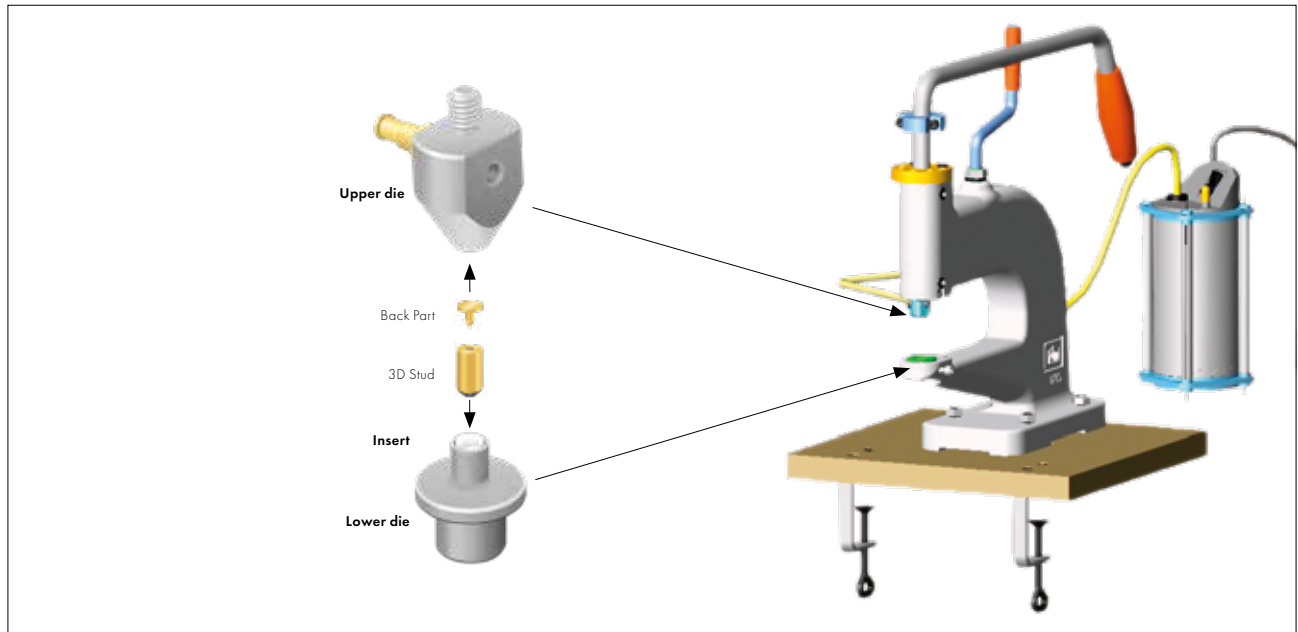

APPLICATION

When the upper and lower die (with insert) are positioned in the fly press, follow the application steps:



1 Place the 3D Stud in the lower die, with the crystal side pointing downwards.



2 Attach the vacuum pump to the upper die and turn the vacuum pump on. The Back Part can now easily be positioned into the upper die with the arrow pointing downwards.



3 Position the carrier material with the right side pointing downwards. Apply the 3D Stud by carefully closing the handle of the fly press.

Changing the plastic insert



1 When a 3D Stud of another size is being applied, the corresponding plastic insert has to be changed first.

2 Take the lower die out of the fly press and press the changing pin through the small hole at the rear side of the lower die to uncase the plastic insert.

3 Choose the matching insert for applying a 3D Stud of another size and push it into the lower die. Make sure the cavity of the insert is located at the upper side of the tool.

Even positioning of 3D Studs with fly press

To facilitate the even positioning of 3D Studs, the linear grid tool can be used. By enclosing already applied 3D Studs it makes it possible to apply further 3D Studs

very close to the existing ones. The linear grid tool has to be positioned on top of the lower die as shown in the following illustration:

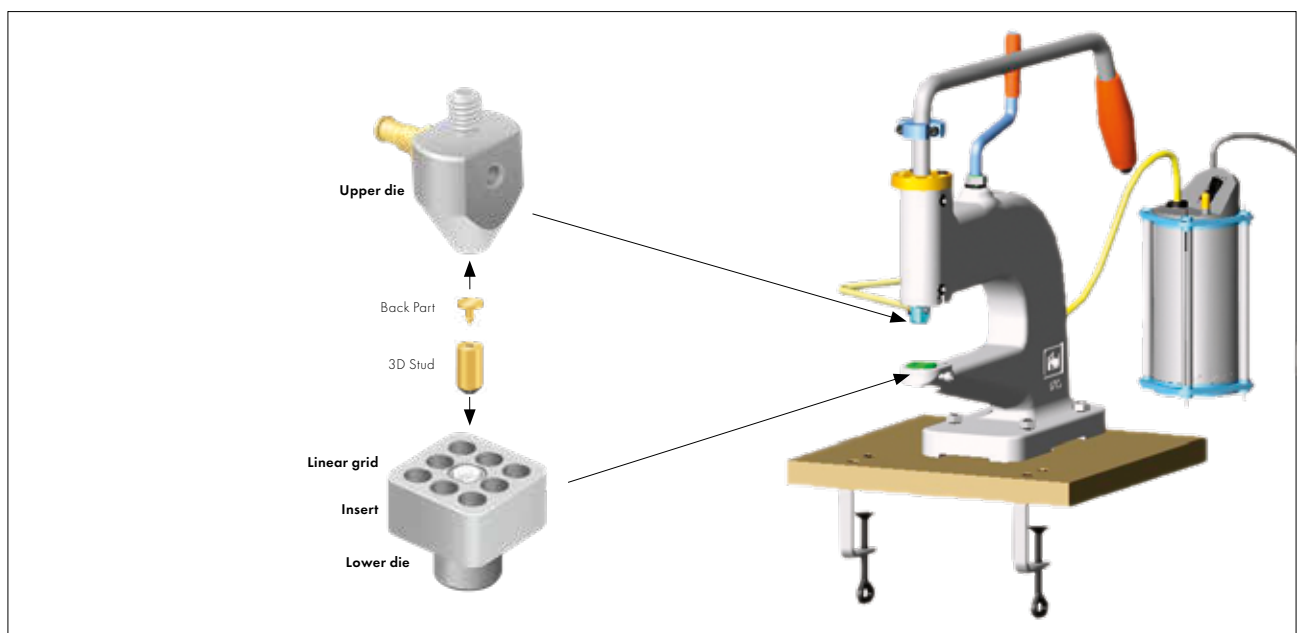

When the upper and lower die (with insert) are positioned in the fly press, follow the application steps:



1 Position the linear grid on top of the lower die.



2 Set a 3D Stud, crystal pointing downwards, in the lower die with proper insert (big cavity in the middle of the linear grid).



3 Turn the fabric around, place an already applied 3D Stud in one of the linear grid's cavities, crystal side facing down.



4 Place a Back Part in the upper die and close the handle of the fly press.



5 Now the 3D Stud is applied evenly and close to another 3D Stud.

APPLICATION

CRYSTAL APPLICATION INSTRUCTION MOVIE

3D Studs - Application with fly press

Learn how to apply 3D Studs using a fly press by watching our instruction movie online at <http://swarovski.com/3-studs-fly-press>



Application with 3D Stud mold

When a bigger quantity of 3D Studs that are one size or different sizes are applied at once, the use of a mold and a hydraulic press is recommended. Please acquire the mold and suitable tools directly from the

supplier Gruppo Meccaniche Luciani (www.gruppomeccanicheluciani.com). Detailed information can be requested from the supplier.

When applying more than 100 3D Studs, the 3D Stud mold application is up to four times faster compared to the application with fly press.



- 1 Before starting production with a new motif, the mask for the vacuum suction has to be fixed in the mold. Open the cover's plates by unscrewing the screws with a drill.

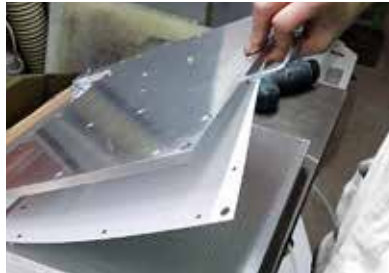

- 2 Place the mask for the vacuum suction channels between the two cover plates.



- 3 Screw the plates together.



- 4 Place a mask at the lower part of the mold. This mask fixes the metal pins which we insert later

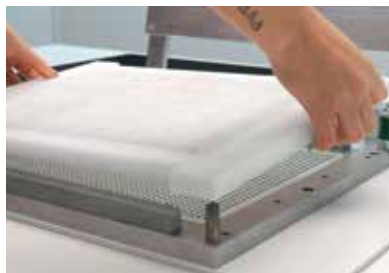

- 5 Next, fix the plastic plate in the mold. In this plate we will later insert the colored metal pins and the 3D Studs.



- 6 Place the first PVC mask onto the lower part of the mold.

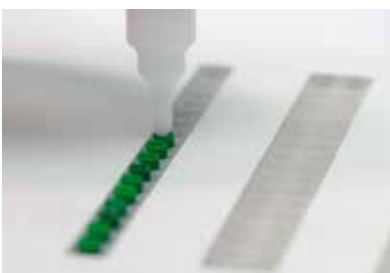

- 7 Insert the first metal pins into the mask's cavities, colored part upwards. Use the plastic pen to press down every single metal pin.



- 8 Place the next masks for another Stud size, insert proper metal pins and press them down again using the plastic pen. Repeat this steps till all metal pins are set.



- 9 Remove the mask and start to set the 3D Studs.



10 Set all 3D Studs with crystals pointing downwards in corresponding cavities.

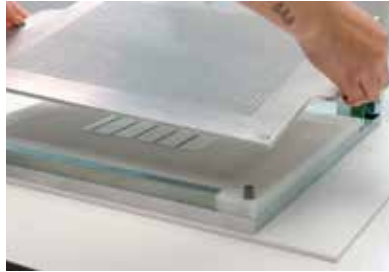

11 Put the middle metal plate back into the mold.



12 Place the first mask for the Back Parts on the middle plate.

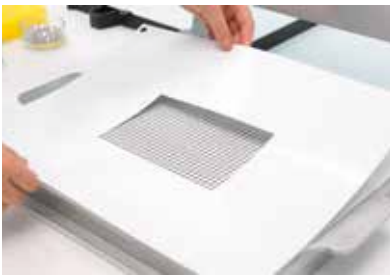

13 Depending on the motif, put another mask for the Back Parts onto the first mask.



14 Place the black frame on the masks. The frame makes sure no Back Parts get lost.



15 Empty the Back Parts onto the black frame and use a sponge to wipe them into the mask's cavities (arrows pointing downwards).

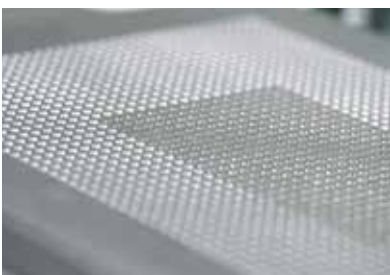

16 Remove the residual Back Parts, the black frame, and the masks. Make sure the middle metal plate stays in the mold.



17 Switch on the vacuum system and close the cover of the mold.



18 Open the cover carefully again, all Back Parts are now attached to the cover.



19 Now remove the middle metal plate and place the fabric carefully in the mold. Right, proper site of fabric is facing down!

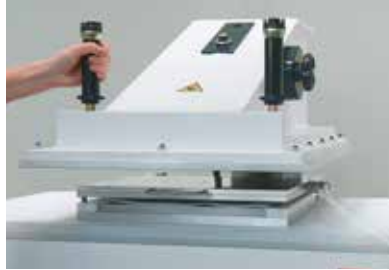

20 Close the cover of the mold and place it in a hydraulic press.

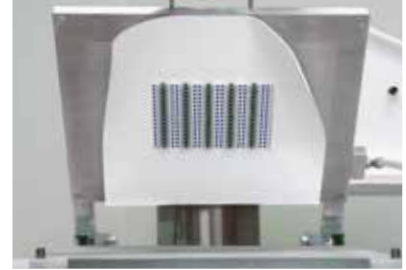

21 Close the press and apply all 3D Studs with one application step. 3D Studs are perfectly applied!

CRYSTAL APPLICATION INSTRUCTION MOVIE

3D Studs - Application with a mold

Learn how to properly apply many 3D Studs simultaneously using a mold by watching instruction movie online at <http://swarovski.com/3-d-studs-mold-press>



USEFUL INFORMATION

OPTIMUM PRODUCT/DIE ALIGNMENT

In general, when carrying out mechanical applications it is important to ensure the proper alignment of products in the dies, so as to avoid any problems.

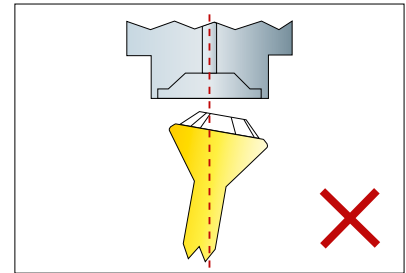
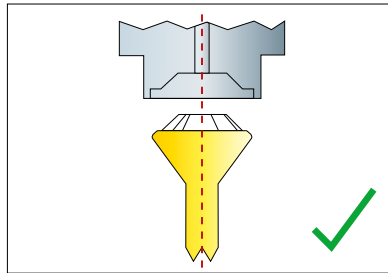

MINIMUM GAPS

Please note that during application, the product is entirely surrounded by the upper die. To prevent neighboring products from being damaged, check the minimum space required by the die when calculating the gap between each item.

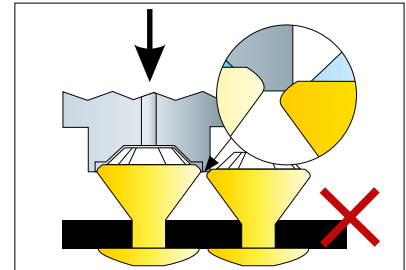
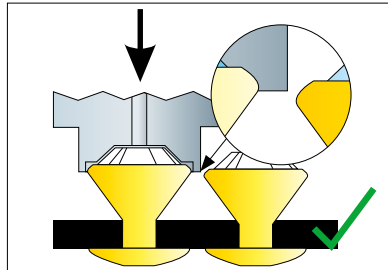

DIE MAINTENANCE

Please check the dies used before and during production, and change them when they become worn.

For machines with vacuum connections, blockages in the upper die can be released using a needle.

QUICK ASSISTANCE

The following table outlines typical mechanical application problems, along with possible causes and recommendations on avoiding them.

PROBLEM	CAUSE
The product is not ideally affixed onto the carrier material.	1, 2, 3, 4, 5
The fabric ripples or crinkles.	2, 3, 4, 5
The dies cannot be inserted in the fly press.	3, 6, 7, 8
It is not possible to unscrew the dies.	6, 8, 9
The crystals break.	2, 3, 4, 5, 10
The crystals do not hold in the upper die.	12, 13

CAUSE	RECOMMENDATION
1 The pressure may be too low.	Apply the product again using increased pressure; adjust the stop.
2 The carrier material is too thick or consists of too many layers.	With Rivets, select the smaller Back Part. With Rivets and Jeans Buttons a hole can be pre-punched.
3 The dies/spare parts for the upper die are defective or have been wrongly inserted.	Check the dies and if necessary, replace or repair them.
4 The product has been applied using the wrong dies.	Check to make sure that the right dies are being used for the product.
5 The dies have not been inserted correctly.	Make sure that the products are placed exactly in the right position on the dies. By turning the fly press handle slowly, it is possible to see if the upper and lower parts of the tool meet exactly.
6 The fly press and dies do not fit together.	Make sure that the fly press and the upper die have the same thread size (M6 or M8).
7 The upper die cannot be fitted.	Check the fastening screw on the upper die; it may have been screwed too tightly.
8 The die/spare part may be damaged.	Check the dies; if they are faulty use a new die or spare part.
9 The screw on the upper die has broken off.	Carefully try to loosen the screw using pliers. Oil from time to time; it may be necessary to center-drill the die.
10 The pressure may be too high.	Apply the product again using slightly less pressure; adjust the stop.
11 The die damages the crystal.	Check the dies and if necessary replace the upper die or the spare parts.
12 The vacuum hose is blocked or damaged.	Check and if necessary change the vacuum hose.
13 The vacuum hole in the upper die is blocked.	Clean the vacuum hole and if necessary change the spare part.





CARE INSTRUCTIONS

To ensure the highest quality and long-lasting applications of Swarovski products, proper care is essential.

- 196** Textile Care Instructions
- 199** General Care Instructions
- 200** Laws, Regulations, Norms, and Standards
- 200** Warning Notices

TEXTILE CARE INSTRUCTIONS

							
GENERAL RECOMMENDATIONS		Turn inside out, choose a gentle wash cycle and use mild laundry detergent. To protect the crystals as much as possible, the use of a soft wash bag is recommended.			Turn inside out and use mild laundry detergent.**	Do not wash!	Chlorine bleach may be used.
Round Stones		✓					
Fancy Stones & Settings	Fancy Stones	✓					
	Settings					✓	
Beads		✓					
BeCharmed & Pavé	BeCharmed Beads & Pavé Balls ¹		✓				
	BeCharmed Rondelles, Charms & Pavé Pendants					✓	
Crystal Pearls	Crystal Pearls	✓					
	Pearl Bow Metal Part					✓	
Pendants						✓	
Flat Backs No Hotfix²		✓					
Flat Backs Hotfix	XILION Rose, XIRIUS Rose ² , Framed Flat Backs & Creation Stones	✓					
	Creation Stones Plus ³				✓		
	Cabochons & Framed Cabochons		✓				
Sew-on Articles		✓					
Transfers	XILION Transfers, XIRIUS Transfers ² , Framed Flat Back Transfers, Creation Transfers & Crystal Diamond Transfers	✓					
	Creation Transfers Plus ³				✓		
	Mezzo Transfers		✓				
	Cabochon Transfers & Framed Cabochon Transfers		✓				
Synthetics Hotfix	Crystal Fabric		✓				
	Crystal Rocks, Crystal Fine Rocks & Crystal Ultrafine Rocks		✓				
	Graphic Fabric, Graphic Rocks, Graphic Fine Rocks & Graphic Ultrafine Rocks				✓		
	Crystal Galuchat, Crystal Medley & Crystaltex		✓				
Self-adhesive Elements	Crystal-it Infinity, Crystal Fabric-it, Crystaltex-it, Crystaltex Chaton-it, Crystal Rocks-it, Crystal Fine Rocks-it, Crystal Ultrafine Rocks-it					✓	
	Crystal Fabric Coldfix, Crystal Fine Rocks Coldfix				✓		
Plastic Trimmings	Basic Bandings	✓					
Crystal Buttons		✓					
Metal Trimmings	Flat Back Bandings/Motifs				✓		
	Rivets, Square Rivets & Star Rivet		✓				
	Spike Rivets				✓		
	Rose Montées, Chaton Montées & Rose Pins		✓				
	3D Studs				✓		
Crystal Mesh					✓		
Cupchains & Findings					✓		

* Colors are machine washable at 60 °C (140 °F). Please take note of the general care instructions in the Application Manual dependent on the product groups where the colors are applied. Swarovski effects are only washable with 40 °C (104 °F) maximum.

** Wash by hand: max. temperature 30 °C (86 °F), very mild process.
1 Wash only with similar colors.
2 XIRIUS size SS40 and SS48: only wash on a hand wash program.

3 Creation Stones Plus have a stone size starting at 8 mm and/or a height starting at 4 mm.

						
		Do not use chlorine bleach!	Turn inside out and dry at reduced temperature.	Do not tumble dry!	Iron inside out using a silk/polyester/viscose setting. Ironing the textile inside out and using a pressing cloth is recommended.	Iron inside out using a wool setting.
Round Stones		✓		✓		
Fancy Stones & Settings	Fancy Stones	✓		✓		
	Settings	✓		✓		
Beads		✓	✓			
BeCharmed & Pavé	BeCharmed Beads & Pavé Balls ¹	✓		✓		
	BeCharmed Rondelles, Charms & Pavé Pendants	✓		✓		
Crystal Pearls	Crystal Pearls	✓	✓			
	Pearl Bow Metal Part	✓				
Pendants		✓		✓		
Flat Backs No Hotfix²		✓		✓		
Flat Backs Hotfix	XILION Rose, XIRIUS Rose ² , Framed Flat Backs & Creation Stones	✓	✓		✓	
	Creation Stones Plus ³	✓		✓		
	Cabochons & Framed Cabochons	✓	✓		✓	
Sew-on Articles		✓		✓		
Transfers	XILION Transfers, XIRIUS Transfers ² , Framed Flat Back Transfers, Creation Transfers & Crystal Diamond Transfers	✓	✓		✓	
	Creation Transfers Plus ³	✓		✓		
	Mezzo Transfers	✓		✓	✓	
	Cabochon Transfers & Framed Cabochon Transfers	✓	✓		✓	
Synthetics Hotfix	Crystal Fabric	✓		✓	✓	
	Crystal Rocks, Crystal Fine Rocks & Crystal Ultrafine Rocks	✓		✓	✓	
	Graphic Fabric, Graphic Rocks, Graphic Fine Rocks & Graphic Ultrafine Rocks	✓		✓	✓	
	Crystal Galuchat, Crystal Medley & Crystaltex	✓		✓	✓	
Self-adhesive Elements	Crystal-it Infinity, Crystal Fabric-it, Crystaltex-it, Crystaltex Chaton-it, Crystal Rocks-it, Crystal Fine Rocks-it, Crystal Ultrafine Rocks-it					
	Crystal Fabric Coldfix, Crystal Fine Rocks Coldfix	✓		✓		
Plastic Trimmings	Basic Bandings	✓	✓			
Crystal Buttons		✓		✓		
Metal Trimmings	Flat Back Bandings/Motifs	✓		✓		
	Rivets, Square Rivets & Star Rivet	✓		✓		
	Spike Rivets	✓		✓		
	Rose Montées, Chaton Montées & Rose Pins	✓		✓		
	3D Studs	✓		✓		
Crystal Mesh		✓		✓		
Cupchains & Findings		✓		✓		

1 Wash only with similar colors.

2 XIRIUS size SS 40 and SS 48: only wash on a hand wash program.

3 Creation Stones Plus have a stone size starting at 8 mm and/or a height starting at 4 mm.

TEXTILE CARE INSTRUCTIONS

						
		Do not iron!	The textile can be gently dry-cleaned using perchlorethylene. Turn inside out.	The textile can be gently dry-cleaned using hydrocarbon. Turn inside out.	The textile will withstand gentle professional wet cleaning. Turn inside out.	The textile may not be dry-cleaned.
			To protect the crystals as much as possible, the use of a soft wash bag is recommended.			
Round Stones		✓		✓	✓	
Fancy Stones & Settings	Fancy Stones	✓		✓	✓	
	Settings	✓				✓
Beads		✓	✓	✓	✓	
BeCharmed & Pavé	BeCharmed Beads & Pavé Balls ¹	✓		✓	✓	
	BeCharmed Rondelles, Charms & Pavé Pendants	✓				✓
Crystal Pearls	Crystal Pearls	✓	✓	✓	✓	
	Pearl Bow Metal Part					
Pendants		✓				✓
Flat Backs No Hotfix²		✓		✓	✓	
Flat Backs Hotfix	XILION Rose, XIRIUS Rose ² , Framed Flat Backs & Creation Stones		✓	✓	✓	
	Creation Stones Plus ³	✓	✓	✓	✓	
	Cabochons & Framed Cabochons		✓	✓	✓	
Sew-on Articles		✓	✓	✓	✓	
Transfers	XILION Transfers, XIRIUS Transfers ² , Framed Flat Back Transfers, Creation Transfers & Crystal Diamond Transfers		✓	✓	✓	
	Creation Transfers Plus ³	✓	✓	✓	✓	
	Mezzo Transfers			✓	✓	
	Cabochon Transfers & Framed Cabochon Transfers		✓	✓	✓	
Synthetics Hotfix	Crystal Fabric			✓	✓	
	Crystal Rocks, Crystal Fine Rocks & Crystal Ultrafine Rocks			✓	✓	
	Graphic Fabric, Graphic Rocks, Graphic Fine Rocks & Graphic Ultrafine Rocks			✓	✓	
	Crystal Galuchat, Crystal Medley & Crystaltex			✓	✓	
Self-adhesive Elements	Crystal-it Infinity, Crystal Fabric-it, Crystaltex-it, Crystaltex Chaton-it, Crystal Rocks-it, Crystal Fine Rocks-it, Crystal Ultrafine Rocks-it					
	Crystal Fabric Coldfix, Crystal Fine Rocks Coldfix	✓			✓	
Plastic Trimmings	Basic Bandings	✓	✓	✓	✓	
Crystal Buttons		✓	✓	✓	✓	
Metal Trimmings	Flat Back Bandings/Motifs	✓		✓	✓	
	Rivets, Square Rivets & Star Rivet	✓	✓	✓	✓	
	Spike Rivets	✓	✓	✓	✓	
	Rose Montées, Chaton Montées & Rose Pins	✓	✓	✓	✓	
	3D Studs	✓		✓	✓	
Crystal Mesh		✓		✓	✓	
Cupchains & Findings		✓				✓

1 Wash only with similar colors.

2 XIRIUS size SS 40 and SS 48: only wash on a hand wash program.

3 Creation Stones Plus have a stone size starting at 8 mm and/or a height starting at 4 mm.

GENERAL CARE INSTRUCTIONS

A light layer of dust is most easily removed with a clean, dry and antistatic cloth. To avoid unsightly fingerprints on the crystal, wear white cotton gloves during the cleaning process. For heavier dirt, lukewarm water with a little dishwashing detergent will suffice. Ideally you should use a damp and clean microfiber or thin, lint-free cotton cloth. Gently wipe each individual crystal and dry

with a clean cloth. Again, wearing white cotton gloves is recommended.

When cleaning with moisture, make sure to use cleaning agents that do not damage the surrounding material. By correctly cleaning your Swarovski crystals, you will restore their full reflectivity.



Cloth

Not following Swarovski care instructions can damage the product and thus lead to damage of textiles or other damage.

Please note that with all standard washing processes (whether carried out by a household washing machine or via dry cleaning) the rotation of the drum places significant mechanical forces on the textiles. The most important factor in ensuring a secure wash is correctly applying the product, without compromising its adhesion. The larger the product employed, and the more products are applied next to each other, the greater the risk of damage. Swarovski products are made out of crystal or contain crystal and must thus be handled with suitable care.

In general, it is recommended that a soft wash bag is used and that the washer drum is filled to protect against damage. To maintain the quality of crystals from Swarovski, the following is also important: before washing, turn items of clothing inside out, select a gentle wash cycle, and use a mild detergent. According to DIN EN ISO 3758, our care instructions list all product groups, meaning each product used by customers must be assessed separately with regard to its washability and suitability for its purpose/the end product. The recommendations given by Swarovski reflect our current level of knowledge. Swarovski uses these recommendations to decide on the suitability of the product for textile applications. Customers are solely

responsible for defining the recommended cleaning process for the end product, and must consider the care advice of Swarovski and any other manufacturers in doing so. The type of shape, cut, surface effect, and size, as well as the weight of the application and the quantity of crystals used has a significant impact on the cleaning process to be followed.

To avoid all risks, customers/textile cleaning companies should remove any large crystal stones, buttons, etc., that have been stitched on before cleaning, and stitch them back on again afterwards.

LAWS, REGULATIONS, NORMS, AND STANDARDS

The composition of loose and forward-integrated crystals in the Advanced Crystal standard is compliant with regulatory industry norms and laws regarding the restriction or prohibition of certain substances

for finished products in the most relevant segments of our customers' businesses. Further information can be found at SWAROVSKI-PROFESSIONAL.COM.

WARNING NOTICES

General Warning



Loose crystals may present a small parts hazard to young children, particularly children under three years old. Depending on the size of the crystal and any attached material (such as glue, fabric, etc.), children may choke on, inhale, swallow, or insert the crystal into their noses. Magnetic products with crystal applications pose a particular risk of serious intestinal injury if ingested. The application techniques as stated in the Application Manual do not guarantee that crystals will not come loose or chip. For each application, the manufacturer must determine whether the product meets the relevant requirements related to small parts hazards and assess any risk it may pose, in particular to small children. Failure to follow Swarovski's care instructions may result in damage to the crystal, which could pose a risk of laceration or other harm.

Warning for Tableware

The application of loose crystals to tableware presents a potential risk of aspiration, choking, swallowing, or tooth damage should crystals become loose. To reduce this risk, crystals should never be applied to any surface of tableware likely to come in contact with food or the mouth, and crystals should never be placed on any tableware intended for use by children. Tableware with crystals intended for decorative use only should be marked as such. To avoid dishwasher damage, tableware decorated with crystals should be washed by hand. The application techniques or suggestions in this manual do not guarantee that crystals will not come loose. For each application, the manufacturer must determine whether the product meets relevant requirements related to small parts hazards or use in food contact items and assess any risk it may pose to users. The use of crystals (which may contain restricted substances deemed hazardous under local laws) and adhesives on tableware is subject to legal restrictions in specific countries. The customer is fully responsible for complying with these country-specific provisions and shall defend, indemnify, and hold Swarovski harmless from any and all third-party claims based on product liability or otherwise relating to uses of Swarovski products, and waives all its own claims against Swarovski.

Unsuitable Applications

Crystals from Swarovski are intended for use in the fields of fashion, jewelry, accessories, textile products, and for interior décor. Due to their physical properties, crystals from Swarovski are unsuitable for other uses (e.g. gluing onto teeth, using on or near mucous membranes, and other unsafe uses). The customer shall defend, indemnify, and hold Swarovski harmless from any and all third-party claims based on product liability or otherwise relating to uses of Swarovski products purchased by the customer, and waives all its own claims.

Responsibility of User

Failure to follow Swarovski's care instructions may result in damage to the crystal, which could pose a risk of laceration or other harm. Any verbal, written, or test-based advice that Swarovski provides regarding techniques for the application of its products is a recommendation based on Swarovski's current knowledge and the information provided by its suppliers. Such advice does not discharge the customer from carrying out its own tests of techniques it proposes to use and their suitability for the intended application. The application, use, and processing of these techniques and products are solely the user's responsibility.

Change of Product

Swarovski reserves the right to modify the dimensions, shape, composition and concentration of components belonging to products that are referred to in this Product Information brochure. Furthermore, any applicable laws and regulations mentioned are subject to change, which is why Swarovski regularly publishes an updated version of the Product Information brochure containing facts, (application) instructions, and the current legal situation that is valid at the time of publication. References to compliance with such regulations as are stated above are based on their requirements as of the current date. Anyone seeking an in-depth understanding of the provisions should read the various laws in their entirety and/or seek advice from a legal counsel.

The customer must request and observe the valid version of the Product Information brochure before (re)ordering and using the products.

NOTES

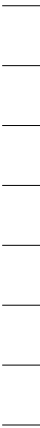

VALID FROM SEPTEMBER 2018

Content is subject to change without notice.

Errors and misprints excepted.

Please note, the actual products may deviate from the pictures in color and effect.

D. Swarovski Distribution GmbH, Swarovskistrasse 30, 6112 Wattens, Austria

© 2018 D. Swarovski Distribution GmbH. All rights reserved. Partial or total publication, transmission, copy or other duplication of texts, graphics, pictures etc. which are to be found in this publication is forbidden without special consent by D. Swarovski Distribution GmbH.

Swarovski® is a registered trademark of Swarovski AG.

Please visit our website for contact information: SWAROVSKI-PROFESSIONAL.COM



*Swarovski Professional is a certified member of RJC